

**2024**

**INDOOR LIGHTING**

**BeatiLux**

**Thank you**

**We are highly welcome you to visit our company.**

**BeatiNeon American Lighting Inc**

Tel: (949)614-8838

Email: [admin@beatineon.us](mailto:admin@beatineon.us)

Office: 15791 Rockfield Blvd, Ste B, Irvine, CA 92618-2811CA

Showroom: 22511 Aspan St, Unit G, Lake Forest, CA 92630

TX Showroom: Dallas Market Center, 2100 N Stemmons Fwy,  
No. 4432-18, Dallas, TX 75207

[www.Beatineon.us](http://www.Beatineon.us)

**BeatiLux**<sup>®</sup>

## SHOWROOM



## HIGH EFFICIENCY LED LINEAR LIGHT

### OUR PARTNER



### OUR CERTIFICATE





**HIGH EFFICIENCY**  
LED LINEAR LIGHT



# BX-802A

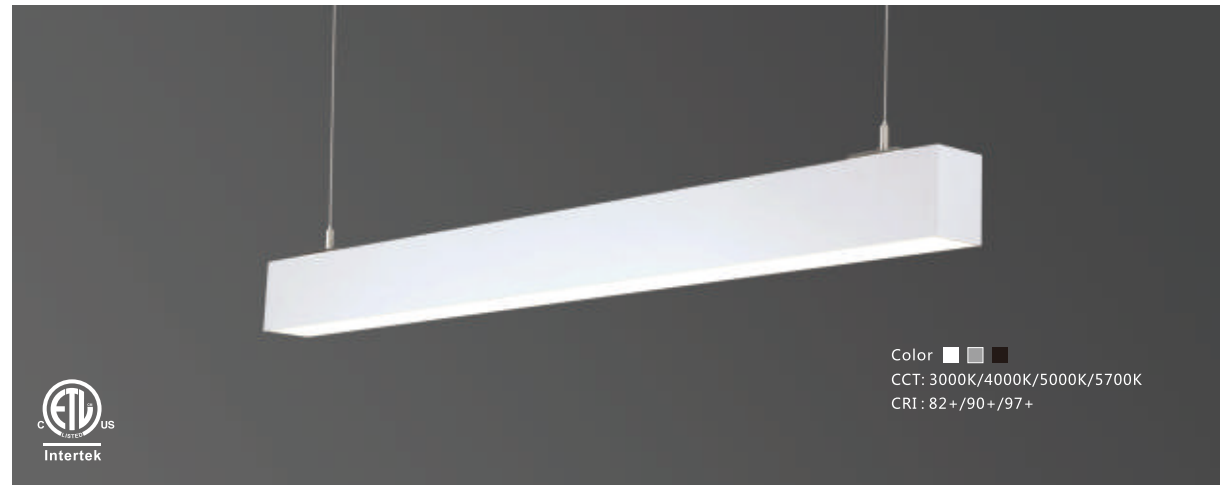

## Product Features

- Equipped with non-flicking driver and high lumen SMD led chip.
- Options for 1-10V dimming,dali dimming and color changing driver.
- Long lifespan up to 50000hours,low decay and low maintenance cost.
- Die-casting end-caps,No screw to be appeared,No light leak.
- High grade aluminum,high quality surface painting.
- Fast and easy connection with no shadow.
- High efficiency PMMA and even light .distribution,no shawdon,anti-glare feature, easy installation to any shape.
- Application:Office,School,Hospital,Supermarket,Shopping Mall,Hotel,Public Area

## Product Size

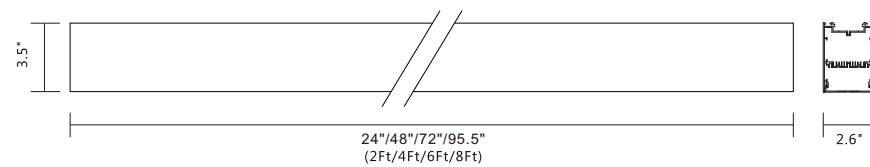

Item No.	Dimension	Power	Distribution	Flux(Lumen)
<b>BX-802A-600-18W</b>	2FT/24"x2.6"x3.5"	18W	Down	1800LM
<b>BX-802A-1200-36W</b>	4FT/48"x2.6"x3.5"	36W	Down	3600LM
<b>BX-802A-1800-54W</b>	6FT/72"x2.6"x3.5"	54W	Down	5400LM
<b>BX-802A-2400-72W</b>	8FT/95.5"x2.6"x3.5"	72W	Down	7200LM
<b>BX-802AU-600-27W</b>	2FT/24"x2.6"x3.5"	27W	UP&Down	2700LM
<b>BX-802AU-1200-54W</b>	4FT/48"x2.6"x3.5"	54W	UP&Down	5400LM
<b>BX-802AU-1800-81W</b>	6FT/72"x2.6"x3.5"	81W	UP&Down	8100LM
<b>BX-802AU-2400-108W</b>	8FT/95.5"x2.6"x3.5"	108W	UP&Down	10800LM

## Light Distribution Curve

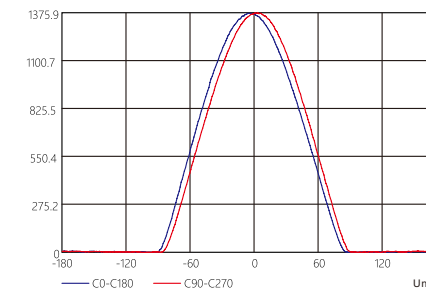
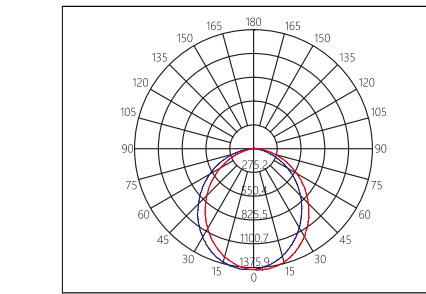

Height	Center lx	Diameter
1.m	1367.76 lx	225.07cm
2.m	341.94 lx	510.14cm
3.m	151.97 lx	765.21cm
5.m	54.71 lx	1275.35cm
8.m	21.37 lx	2040.56cm
12.m	9.50 lx	3060.83cm
16.m	5.34 lx	4081.11cm

Beam Angle:103.80°(50%Imax)

## Connector

	180° extender	3"x0.8"x0.07"		L-shape Connector	12"x12"x2.5"x3.5"
	T-shape Connector	22"x13"x2.5"x3.5"		X-shape Connector	22"x23"x2.5"x3.5"

## Mounting

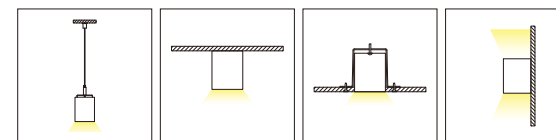

## Accessories

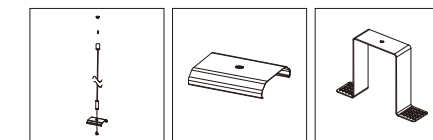

## Dimming



## Linear Continous

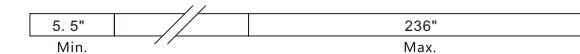

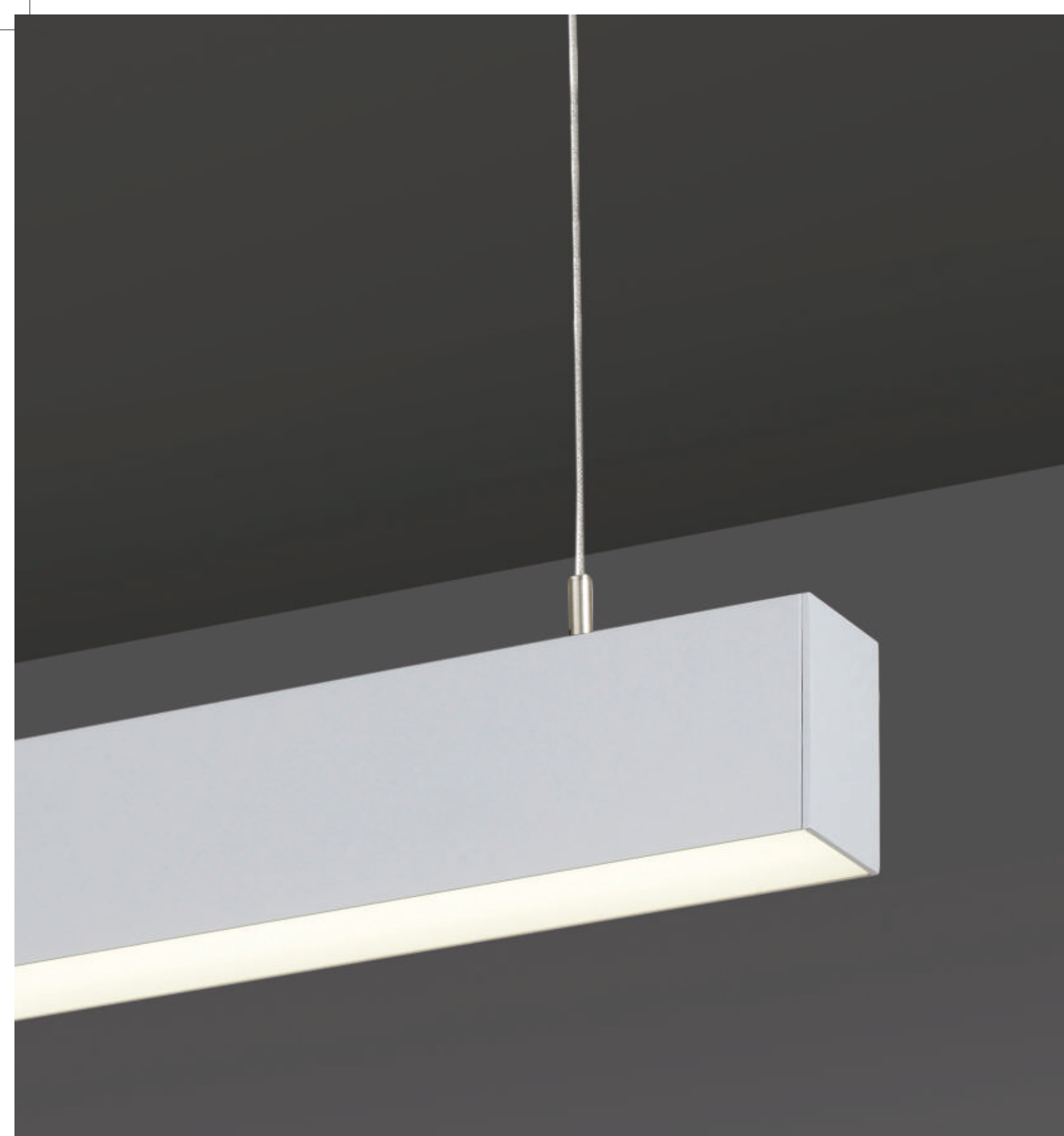

**BeatiLux®**

Easy Installation  
Fast Connection  
5 Years Warranty



# CONNECTION

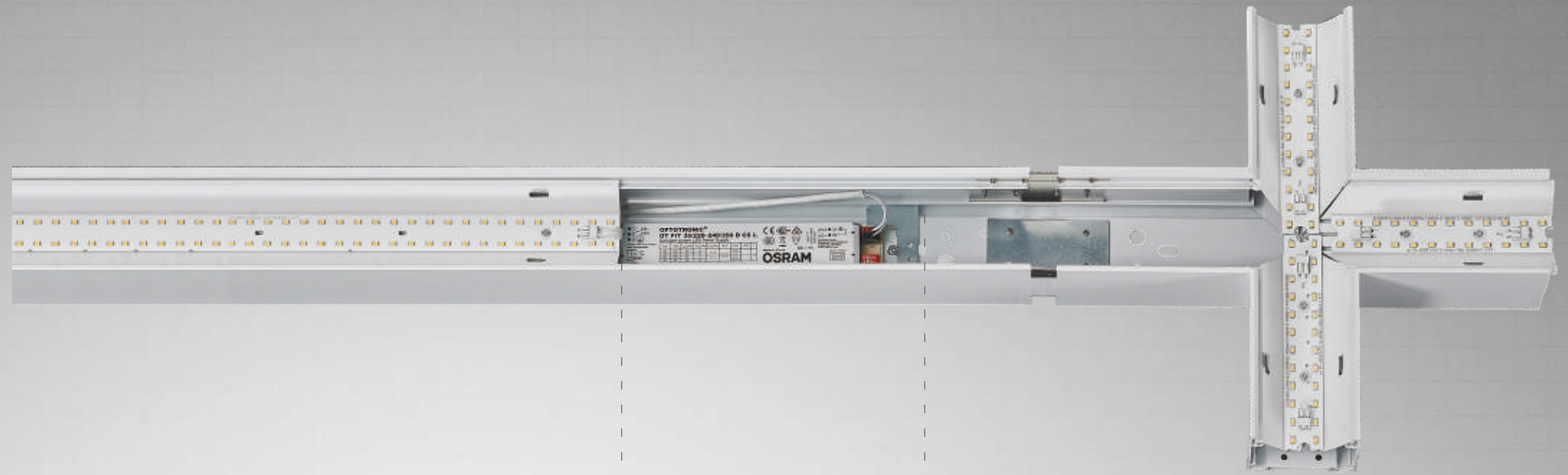

## Linear Continuous

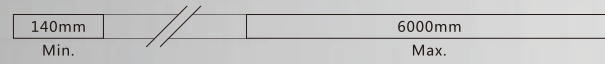

EPISTAR

OSRAM

SAMSUNG

LIFUD

EVERLIGHT

PHILIPS

TRIDONIC



# BX-805A

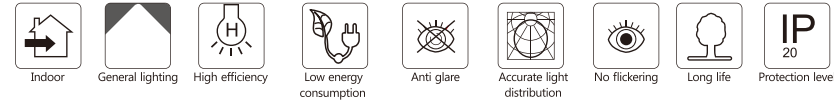

## Product Features

- Equipped with non-flicking driver and high lumen SMD led chip,
- Options for 1-10V dimming,dali dimming and color changing driver.
- Long lifespan up to 50000hours,low decay and low maintenance cost.
- Die-casting end-caps,No screw to be appeared,No light leak.
- High grade aluminum,high quality surface painting.
- Fast and easy connection with no shadow.
- High efficiency PMMA and even light .distribution,no shawdon,anti-glare feature, easy installation to any shape.
- Application:Office,School,Hospital,Supermarket,Shopping Mall,Hotel,Public Area

## Product Size

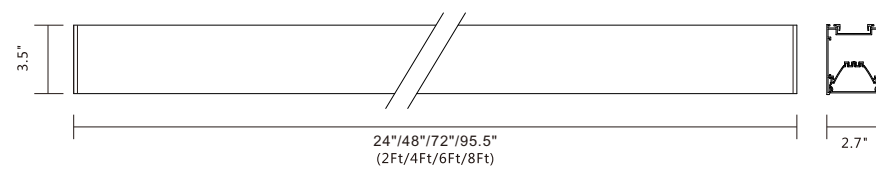

Item No.	Dimension	Power	Distribution	Flux(Lumen)
<b>BX-805A-600-18W</b>	2FT/24"x2.7"x3.5"	18W	Down	1800LM
<b>BX-805A-1200-36W</b>	4FT/48"x2.7"x3.5"	36W	Down	3600LM
<b>BX-805A-1800-54W</b>	6FT/72"x2.7"x3.5"	54W	Down	5400LM
<b>BX-805A-2400-72W</b>	8FT/95.5"x2.7"x3.5"	72W	Down	7200LM
<b>BX-805AU-600-27W</b>	2FT/24"x2.7"x3.5"	27W	UP&Down	2700LM
<b>BX-805AU-1200-54W</b>	4FT/48"x2.7"x3.5"	54W	UP&Down	5400LM
<b>BX-805AU-1800-81W</b>	6FT/72"x2.7"x3.5"	81W	UP&Down	8100LM
<b>BX-805AU-2400-108W</b>	8FT/95.5"x2.7"x3.5"	108W	UP&Down	10800LM

## Light Distribution Curve

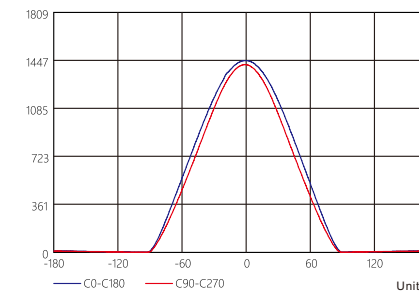
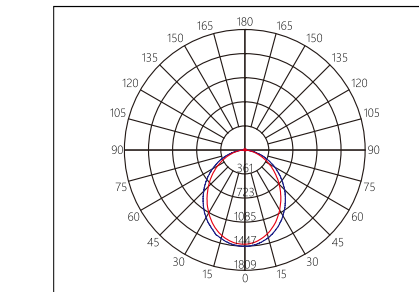

H(m)	E0(lx)	Dh/Dv: R(m)	S: R(sq.m)	Eav: R(lx)
1.0	1447.42	2.51/2.16	4.4	306.43
2.0	361.86	5.02/4.31	17.4	76.61
3.0	160.82	7.53/6.47	39.2	34.05
4.0	90.46	10.04/8.63	69.7	19.15
5.0	57.90	12.55/10.78	109.0	12.26
6.0	40.21	15.06/12.94	156.9	8.51
7.0	29.54	17.57/15.09	213.6	6.25
8.0	22.62	20.08/17.25	279.0	4.79
10.0	14.47	25.10/21.56	435.9	3.06
12.0	10.05	30.12/25.88	627.7	2.13

Half peak angle(B) H102.9 V94.3 Effective beam angle (F) H158.2 V154.2

## Connector 连接件

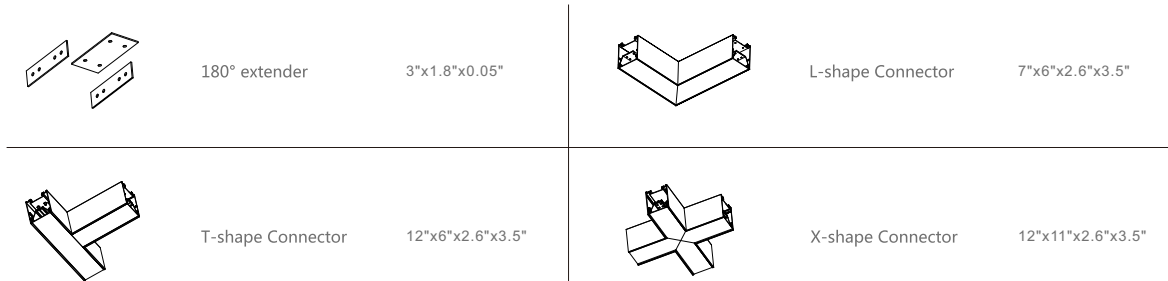

## Mounting

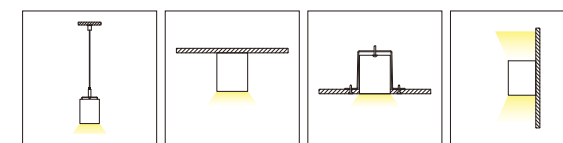

## Accessories

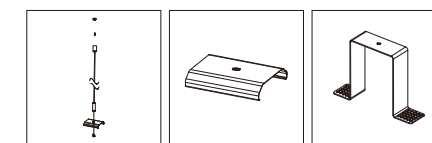

## Dimming



## Linear Continous



# BX-806A



## Product Features

- Equipped with non-flicking driver and high lumen SMD led chip,
- Options for 1-10V dimming,dali dimming and color changing driver.
- Long lifespan up to 50000hours,low decay and low maintenance cost.
- Die-casting end-caps,No screw to be appeared,No light leak.
- High grade aluminum,high quality surface painting.
- Fast and easy connection with no shadow.
- High efficiency PMMA and even light .distribution,no shadow,anti-glare feature, easy installation to any shape.
- Application:Office,School,Hospital,Supermarket,Shopping Mall,Hotel,Public Area

## Product Size

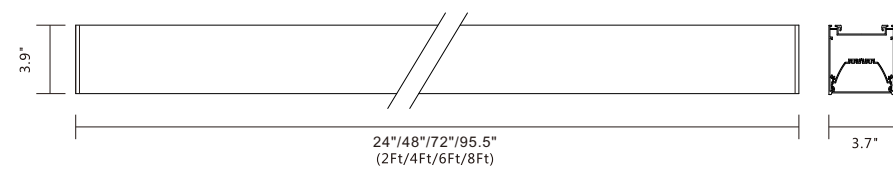

Item No.	Dimension	Power	Distribution	Flux(Lumen)
<b>BX-806A-600-18W</b>	2FT/24"x3.7"x3.9"	18W	Down	1800LM
<b>BX-806A-1200-36W</b>	4FT/48"x3.7"x3.9"	36W	Down	3600LM
<b>BX-806A-1800-54W</b>	6FT/72"x3.7"x3.9"	54W	Down	5400LM
<b>BX-806A-2400-72W</b>	8FT/95.5"x3.7"x3.9"	72W	Down	7200LM
<b>BX-806AU-600-27W</b>	2FT/24"x3.7"x3.9"	27W	UP&Down	2700LM
<b>BX-806AU-1200-54W</b>	4FT/48"x3.7"x3.9"	54W	UP&Down	5400LM
<b>BX-806AU-1800-81W</b>	6FT/72"x3.7"x3.9"	81W	UP&Down	8100LM
<b>BX-806AU-2400-108W</b>	8FT/95.5"x3.7"x3.9"	108W	UP&Down	10800LM

## Light Distribution Curve

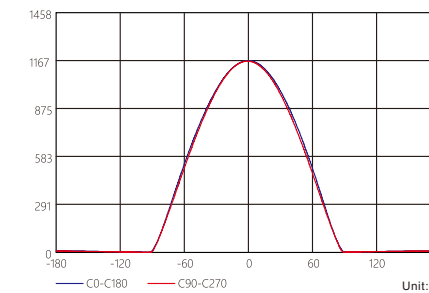
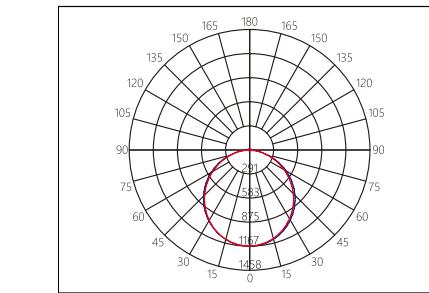

H(m)	E0(lx)	Dh(Dv) B(m)	S.B(m)	Env. B(lx)
1.0	1167.00	3.06/2.90	7.0	195.69
2.0	291.75	6.13/5.81	27.9	48.92
3.0	129.67	9.19/8.71	62.7	21.74
4.0	72.94	12.25/11.61	111.5	12.23
5.0	46.68	15.32/14.52	174.2	7.83
6.0	32.42	18.38/17.42	250.8	5.44
7.0	23.82	21.44/20.33	341.4	3.99
8.0	18.23	24.51/23.23	445.9	3.06
10.0	11.67	30.63/29.04	696.8	1.96
12.0	8.10	36.76/34.84	1003.3	1.36

Half peak angle(B) H113.7 V110.9  
 Effective beam angle (F) H162.3 V162.0

## Connector

	180° extender	3"x2"x0.05"		L-shape Connector	8"x6"x6.5"x3.9"
	T-shape Connector	11"x8"x3.7"x3.9"		X-shape Connector	13"x11"x3.7"x3.9"

## Mounting

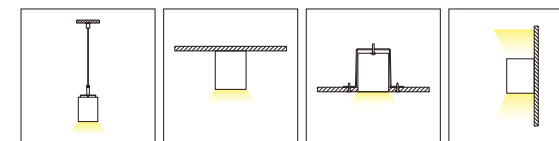

## Accessories

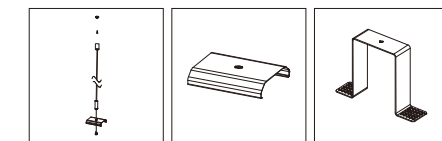

## Dimming



## Linear Continous







**BeatiLux®**

SLIM

# BX-809A

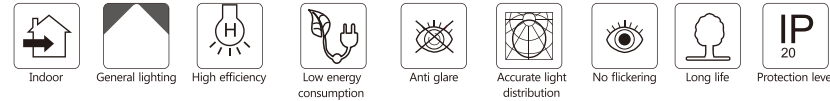

## Product Features

- Equipped with non-flicking driver and high lumen SMD led chip,
- Options for 1-10V dimming,dali dimming and color changing driver.
- Long lifespan up to 50000hours,low decay and low maintenance cost.
- Die-casting end-caps,No screw to be appeared,No light leak.
- High grade aluminum,high quality surface painting.
- Fast and easy connection with no shadow.
- High efficiency PMMA and even light .distribution,no shadow,anti-glare feature, easy installation to any shape.
- Application:Office,School,Hospital,Supermarket,Shopping Mall,Hotel,Public Area

## Product Size

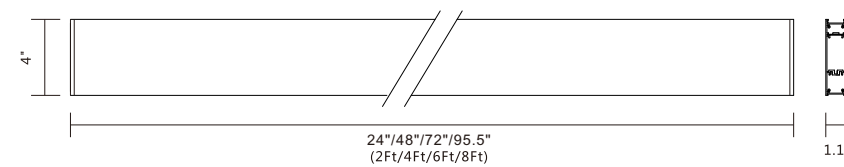

Item No.	Dimension	Power	Distribution	Flux(Lumen)
<b>BX-809A-600-18W</b>	2FT/24"x1.1"x4"	18W	Down	1440LM
<b>BX-809A-1200-36W</b>	4FT/48"x1.1"x4"	36W	Down	2880LM
<b>BX-809A-1800-54W</b>	6FT/72"x1.1"x4"	54W	Down	4320LM
<b>BX-809A-2400-72W</b>	8FT/95.5"x1.1"x4"	72W	Down	5760LM
<b>BX-809AU-600-27W</b>	2FT/24"x1.1"x4"	27W	UP&Down	2160LM
<b>BX-809AU-1200-45W</b>	4FT/48"x1.1"x4"	54W	UP&Down	3600LM
<b>BX-809AU-1800-81W</b>	6FT/72"x1.1"x4"	81W	UP&Down	6480LM
<b>BX-809AU-2400-108W</b>	8FT/95.5"x1.1"x4"	108W	UP&Down	8640LM

## Light Distribution Curve

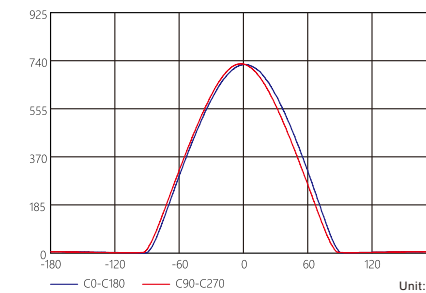
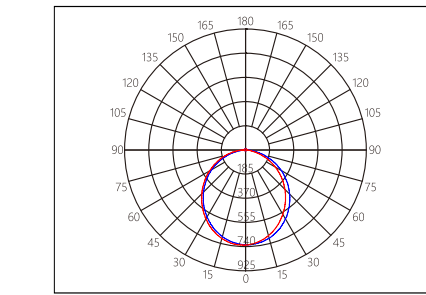

H(m)	E0(lx)	Dh/Dv B(m)	S. B(sq.m)	Eav. B(lx)
1.0	725.93	2.85/2.68	6.1	132.24
2.0	181.48	5.70/5.37	24.3	33.06
3.0	80.66	8.55/8.05	54.7	14.69
4.0	45.37	11.40/10.73	97.2	8.27
5.0	29.04	14.24/13.41	151.8	5.29
6.0	20.16	17.09/16.10	218.7	3.67
7.0	14.81	19.94/18.78	297.6	2.70
8.0	11.34	22.79/21.46	388.7	2.07
10.0	7.26	28.49/26.83	607.4	1.32
12.0	5.04	34.19/32.19	874.6	0.92

Half peak angle(B) H109.9 V106.6  
 Effective beam angle (F) H160.9 V160.4

## Connector

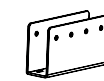

180° extender 3"x1.8"x0.05"

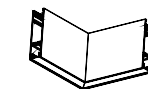

L-shape Connector 6"x5.5"x1"x4"

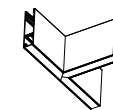

T-shape Connector 12"x5.5"x1"x4"

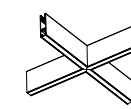

X-shape Connector 12"x11"x1"x4"

## Mounting

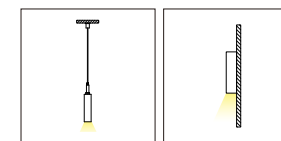

## Accessories

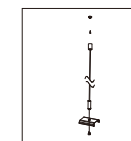

## Dimming



## Linear Continous



# BX-811A

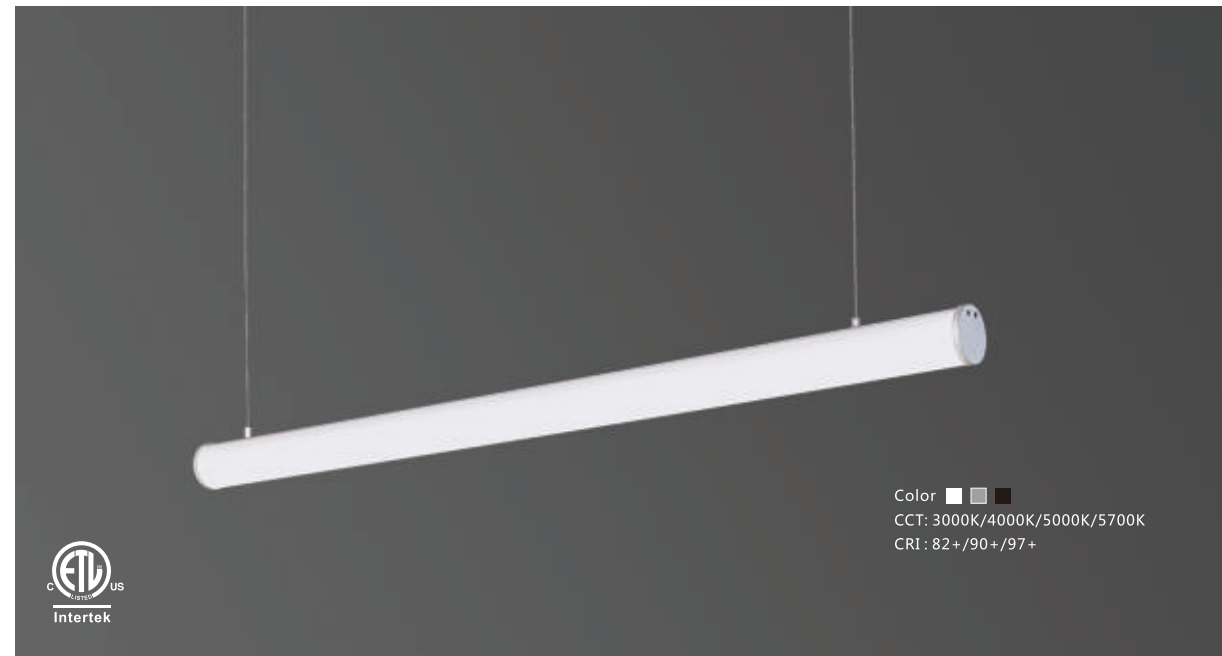
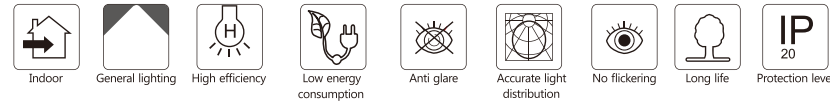

Color     
 CCT: 3000K/4000K/5000K/5700K  
 CRI: 82+/90+/97+

## Product Features

- Equipped with non-flicking driver and high lumen SMD led chip,
- Options for 1-10V dimming,dali dimming and color changing driver.
- Long lifespan up to 50000hours,low decay and low maintenance cost.
- Die-casting end-caps,No screw to be appeared,No light leak.
- High grade aluminum,high quality surface painting.
- Fast and easy connection with no shadow.
- High efficiency PMMA and even light .distribution,no shadow,anti-glare feature,
- easy installation to any shape.
- Application:Office,School,Hospital,Supermarket,Shopping Mall,Hotel,Public Area

## Product Size

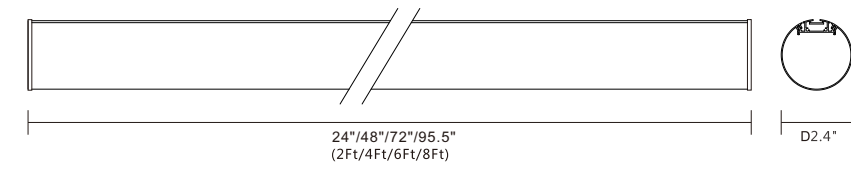

Item No.	Dimension	Power	Distribution	Flux(Lumen)
<b>BX-811A-600-18W</b>	2FT/24"xD2.4"	18W	Down	1980LM
<b>BX-811A-1200-36W</b>	4FT/48"xD2.4"	36W	Down	3960LM
<b>BX-811A-1800-54W</b>	6FT/72"xD2.4"	54W	Down	5940LM
<b>BX-811A-2400-72W</b>	8FT/95.5"xD2.4"	72W	Down	7920LM

## Light Distribution Curve

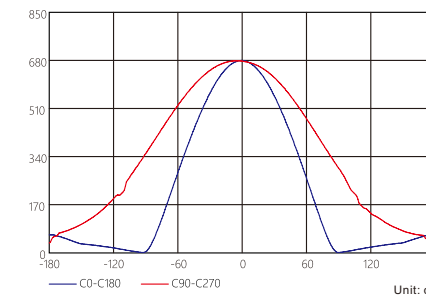
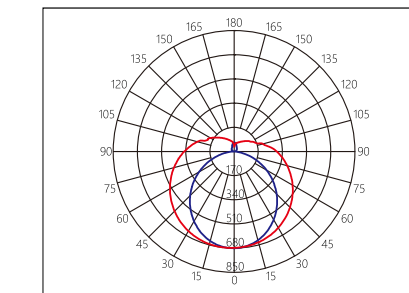

H(m)	E0(lx)	Dh/Dv B(m)	S B(sq.m)	Env B(lx)
1.0	680.01	2.74/46.93	NA	NA
2.0	170.00	5.49/93.86	NA	NA
3.0	75.56	8.23/140.79	NA	NA
4.0	42.50	10.98/187.72	NA	NA
5.0	27.20	13.72/234.65	NA	NA
6.0	18.89	16.47/281.58	NA	NA
7.0	13.88	19.21/328.51	NA	NA
8.0	10.63	21.96/375.44	NA	NA
10.0	6.80	27.44/469.30	NA	NA
12.0	4.72	32.93/563.16	NA	NA

Half peak edge angle(B) H107.8 V175.1  
 Effective beam angle (F) H158.6 V329.7

## Mounting

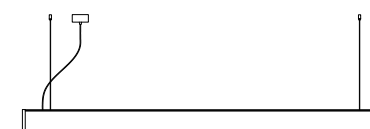

## Dimming



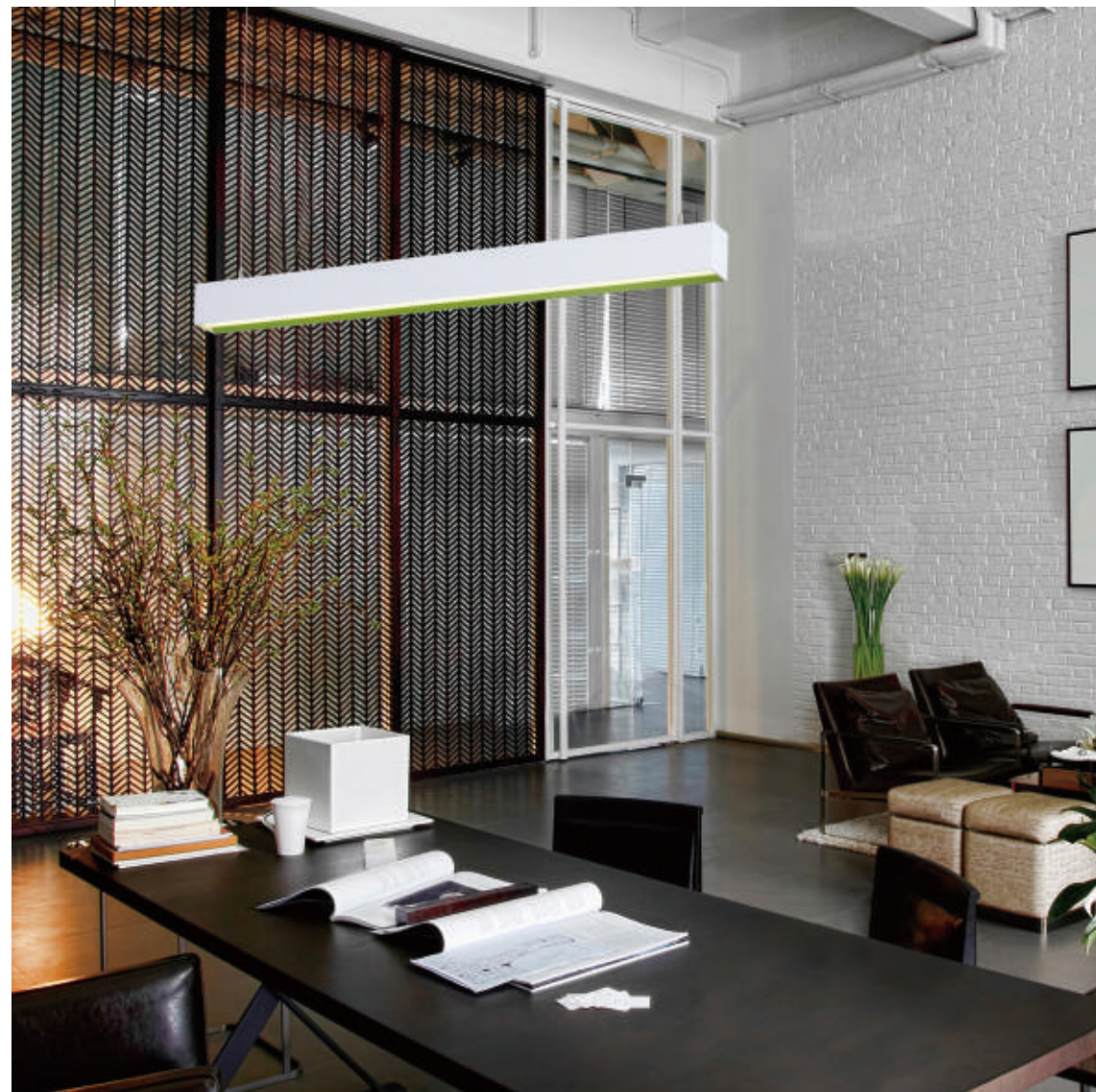

HIGH EFFICIENCY  
LED LINEAR LIGHT



# BX-602B

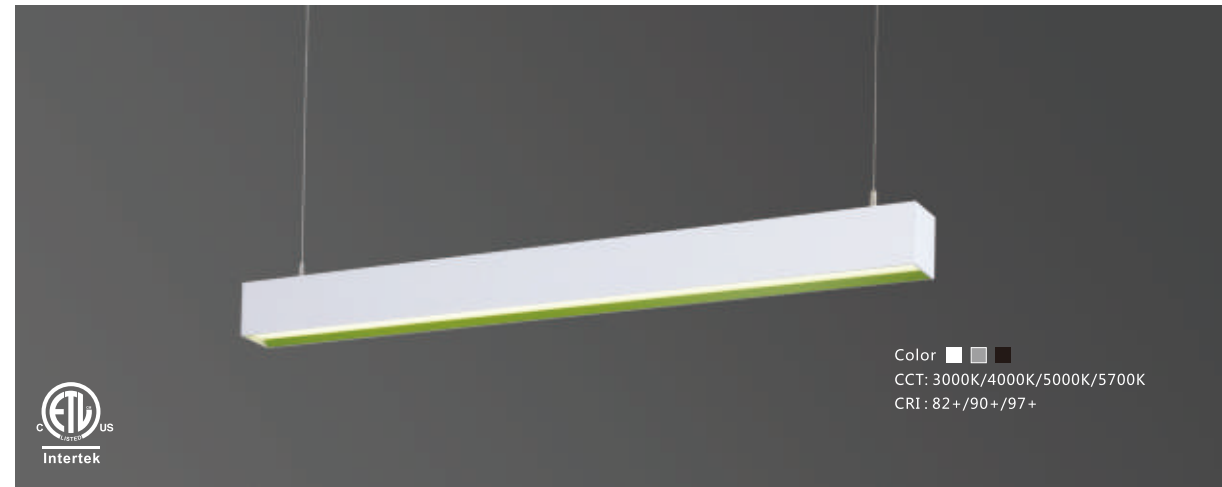

## Product Features

- Equipped with non-flicking driver and high lumen SMD led chip,
- Options for 1-10V dimming,dali dimming and color changing driver.
- Long lifespan up to 50000hours,low decay and low maintenance cost.
- Die-casting end-caps,No screw to be appeared,No light leak.
- High grade aluminum,high quality surface painting.
- Fast and easy connection with no shadow.
- High efficiency PMMA and even light .distribution,no shadow,anti-glare feature, easy installation to any shape.
- Application:Office,School,Hospital,Supermarket,Shopping Mall,Hotel,Public Area

## Product Size

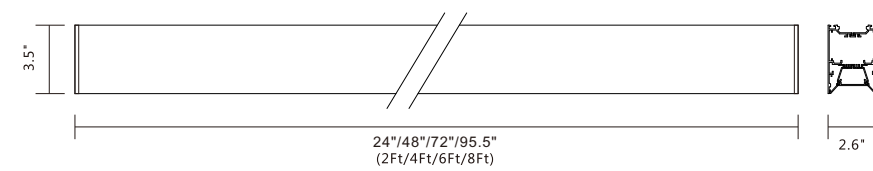

Item No.	Dimension	Power	Distribution	Flux(Lumen)
<b>BX-602B-600-18W</b>	2FT/24"x2.6"x3.5"	18W	Down	1800LM
<b>BX-602B-1200-36W</b>	4FT/48"x2.6"x3.5"	36W	Down	3600LM
<b>BX-602B-1800-54W</b>	6FT/72"x2.6"x3.5"	54W	Down	5400LM
<b>BX-602B-2400-72W</b>	8FT/95.5"x2.6"x3.5"	72W	Down	7200LM
<b>BX-602BU-600-27W</b>	2FT/24"x2.6"x3.5"	27W	UP&Down	2700LM
<b>BX-602BU-1200-54W</b>	4FT/48"x2.6"x3.5"	54W	UP&Down	5400LM
<b>BX-602BU-1800-81W</b>	6FT/72"x2.6"x3.5"	81W	UP&Down	8100LM
<b>BX-602BU-2400-108W</b>	8FT/95.5"x2.6"x3.5"	108W	UP&Down	10800LM

## Light Distribution Curve

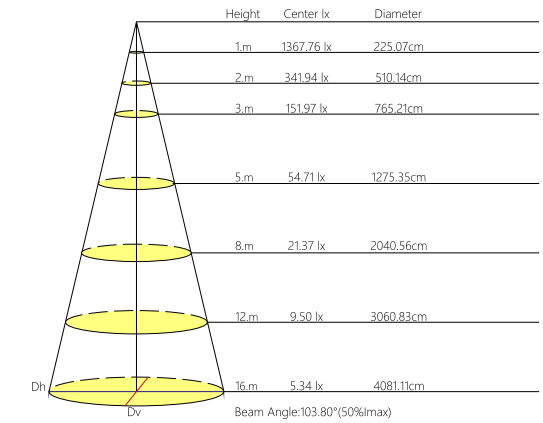
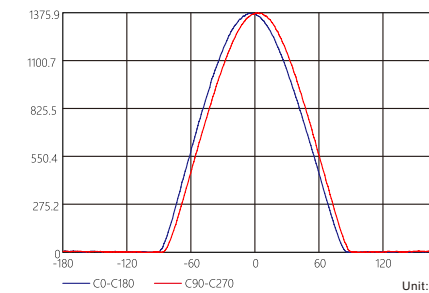
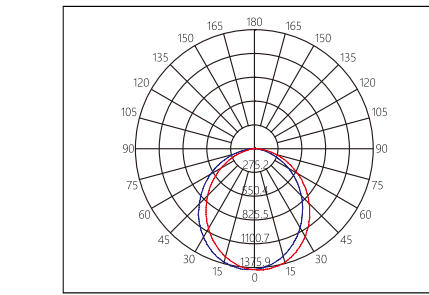

## Connector

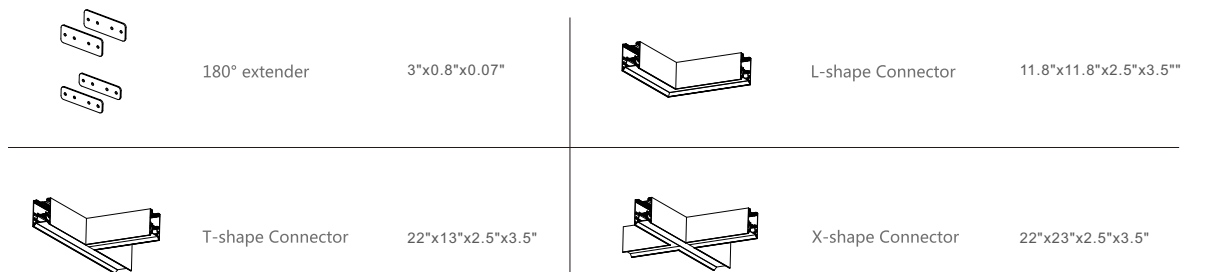

## Mounting

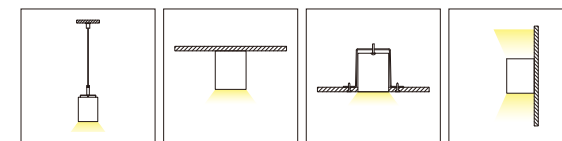

## Accessories

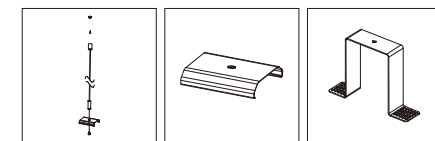

## Dimming



## Linear Continous

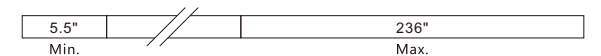

# BX-602C

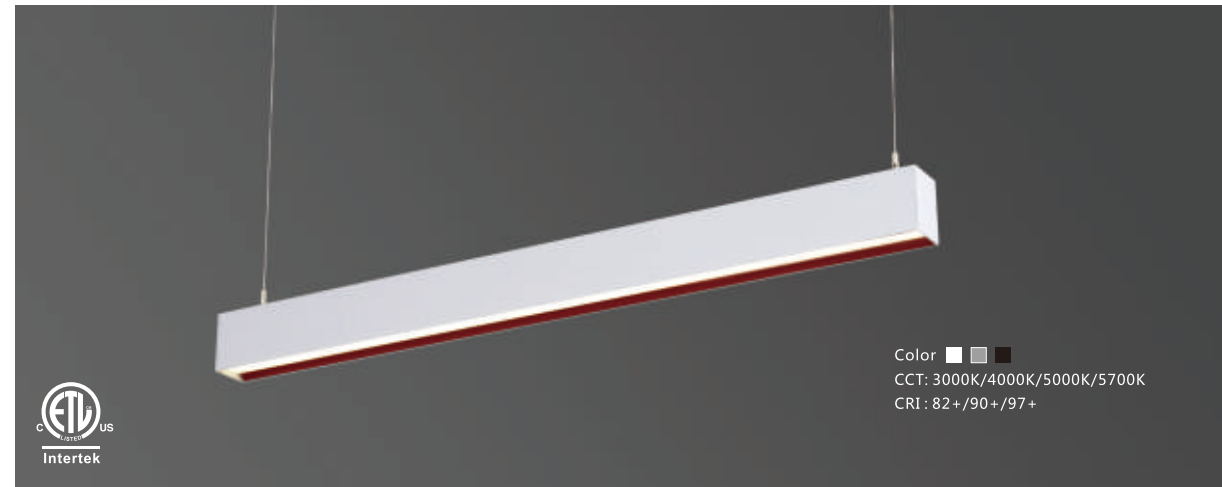

## Product Features

- Equipped with non-flicking driver and high lumen SMD led chip,
- Options for 1-10V dimming,dali dimming and color changing driver.
- Long lifespan up to 50000hours,low decay and low maintenance cost.
- Die-casting end-caps,No screw to be appeared,No light leak.
- High grade aluminum,high quality surface painting.
- Fast and easy connection with no shadow.
- High efficiency PMMA and even light .distribution,no shadow,anti-glare feature, easy installation to any shape.
- Application:Office,School,Hospital,Supermarket,Shopping Mall,Hotel,Public Area

## Product Size

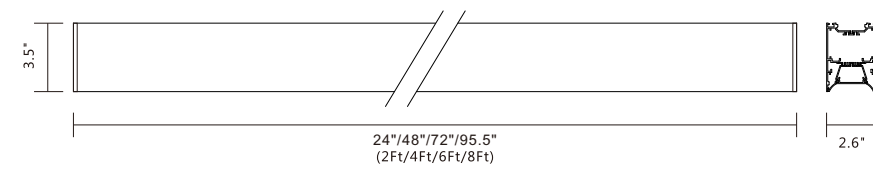

Item No.	Dimension	Power	Distribution	Flux(Lumen)
<b>BX-602C-600-18W</b>	2FT/24"x2.6"x3.5"	18W	Down	1800LM
<b>BX-602C-1200-36W</b>	4FT/48"x2.6"x3.5"	36W	Down	3600LM
<b>BX-602C-1800-54W</b>	6FT/72"x2.6"x3.5"	54W	Down	5400LM
<b>BX-602C-2400-72W</b>	8FT/95.5"x2.6"x3.5"	72W	Down	7200LM
<b>BX-602CU-600-27W</b>	2FT/24"x2.6"x3.5"	27W	UP&Down	2700LM
<b>BX-602CU-1200-54W</b>	4FT/48"x2.6"x3.5"	54W	UP&Down	5400LM
<b>BX-602CU-1800-81W</b>	6FT/72"x2.6"x3.5"	81W	UP&Down	8100LM
<b>BX-602CU-2400-108W</b>	8FT/95.5"x2.6"x3.5"	108W	UP&Down	10800LM

## Light Distribution Curve

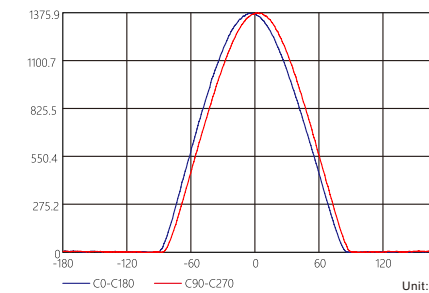
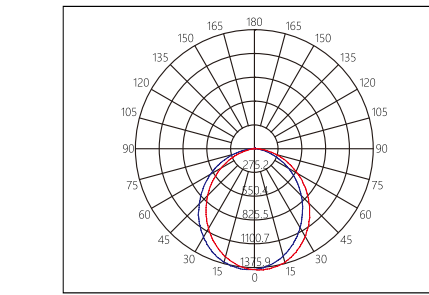

Height	Center lx	Diameter
1.m	1367.76 lx	225.07cm
2.m	341.94 lx	510.14cm
3.m	151.97 lx	765.21cm
5.m	54.71 lx	1275.35cm
8.m	21.37 lx	2040.56cm
12.m	9.50 lx	3060.83cm
16.m	5.34 lx	4081.11cm

Beam Angle:103.80°(50%Imax)

## Connector

	180° extender	3"x0.8"x0.07"		L-shape Connector	11.8"x11.8"x2.5"x3.5"
	T-shape Connector	22"x13"x2.5"x3.5"		X-shape Connector	22"x23"x2.5"x3.5"

## Mounting

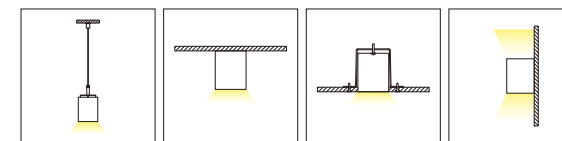

## Accessories

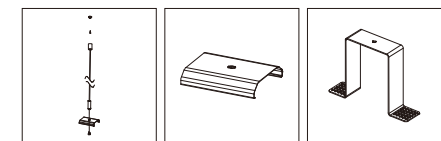

## Dimming



## Linear Continous

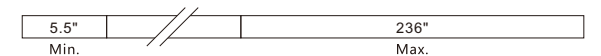

# BX-602D

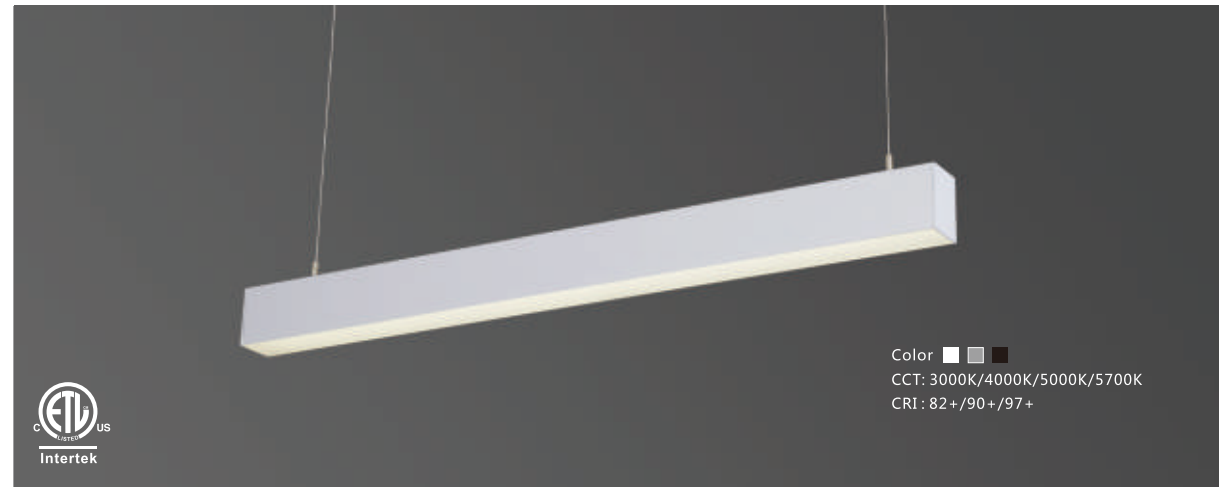

## Product Features

- Equipped with non-flicking driver and high lumen SMD led chip,
- Options for 1-10V dimming,dali dimming and color changing driver.
- Long lifespan up to 50000hours,low decay and low maintenance cost.
- Die-casting end-caps,No screw to be appeared,No light leak.
- High grade aluminum,high quality surface painting.
- Fast and easy connection with no shadow.
- High efficiency PMMA and even light .distribution,no shadow,anti-glare feature, easy installation to any shape.
- Application:Office,School,Hospital,Supermarket,Shopping Mall,Hotel,Public Area

## Product Size

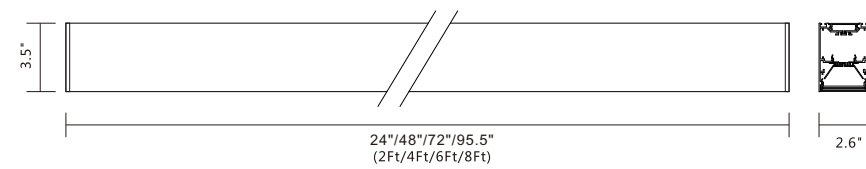

Item No.	Dimension	Power	Distribution	Flux(Lumen)
<b>BX-602D-600-18W</b>	2FT/24"x2.6"x3.5"	18W	Down	1800LM
<b>BX-602D-1200-36W</b>	4FT/48"x2.6"x3.5"	36W	Down	3600LM
<b>BX-602D-1800-54W</b>	6FT/72"x2.6"x3.5"	54W	Down	5400LM
<b>BX-602D-2400-72W</b>	8FT/95.5"x2.6"x3.5"	72W	Down	7200LM
<b>BX-602DU-600-27W</b>	2FT/24"x2.6"x3.5"	27W	UP&Down	2700LM
<b>BX-602DU-1200-54W</b>	4FT/48"x2.6"x3.5"	54W	UP&Down	5400LM
<b>BX-602DU-1800-81W</b>	6FT/72"x2.6"x3.5"	81W	UP&Down	8100LM
<b>BX-602DU-2400-108W</b>	8FT/95.5"x2.6"x3.5"	108W	UP&Down	10800LM

## Light Distribution Curve

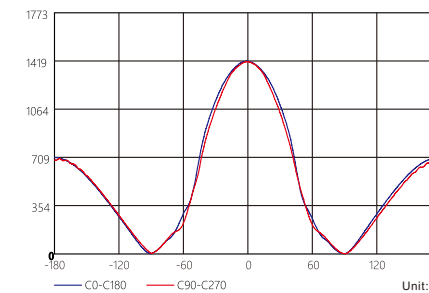
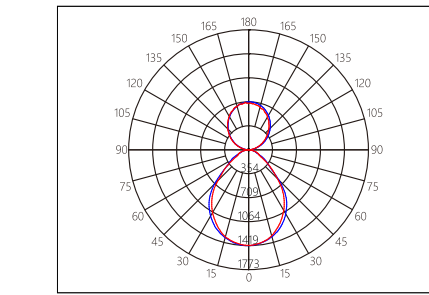

H(m)	E0(ft)	Dh/Dv B(m)	S B(sq.m)	Flux B(lx)
1.0	1418.68	NA/1.85	NA	NA
2.0	354.67	NA/3.70	NA	NA
3.0	157.63	NA/5.55	NA	NA
4.0	88.67	NA/7.39	NA	NA
5.0	56.75	NA/9.24	NA	NA
6.0	39.41	NA/11.09	NA	NA
7.0	28.95	NA/12.94	NA	NA
8.0	22.17	NA/14.79	NA	NA
10.0	14.19	NA/18.49	NA	NA
12.0	9.85	NA/22.18	NA	NA

Half peak angle(B) H360.0 V85.5  
 Effective beam angle (F) H360.0 V360.0

## Connector

	180° extender	3"x0.8"x0.07"		L-shape Connector	11.8"x11.8"x2.5"x3.5"
	T-shape Connector	22"x13"x2.5"x3.5"		X-shape Connector	22"x23"x2.5"x3.5"

## Mounting

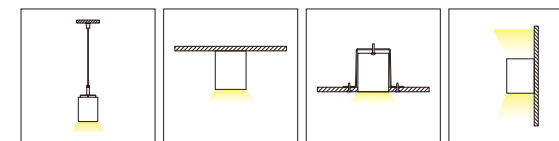

## Accessories

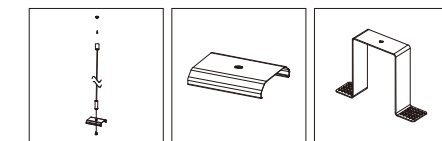

## Dimming



## Linear Continous

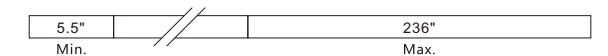



**BeatiLux<sup>®</sup>**

Linear Spot Light  
Anti-glare  
Small Beam Angle  
Direct Spot Light Distribution



# BX-802M1



## Product Features

- Equipped with non-flicking driver and high lumen SMD led chip,
- Options for 1-10V dimming,dali dimming and color changing driver.
- Long lifespan up to 50000hours,low decay and low maintenance cost.
- Die-casting end-caps,No screw to be appeared,No light leak.
- High grade aluminum,high quality surface painting.
- Fast and easy connection with no shadow.
- High efficiency lens and even light .distribution,no shawdon,anti-glare feature, easy installation to any shape.
- Application:Office,School,Hospital,Supermarket,Shopping Mall,Hotel,Public Area

## Product Size

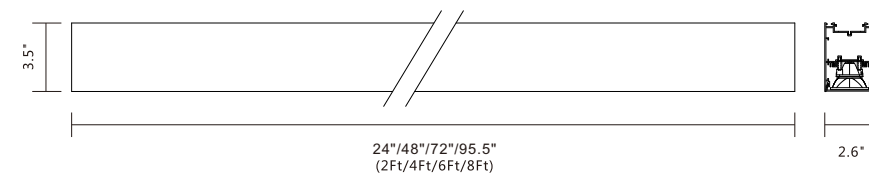

Item No.	Dimension	Power	Distribution	Flux(Lumen)
<b>BX-802M1-600</b>	2FT/24"x2.6"x3.5"	2*10W	Down	1900LM
<b>BX-802M1-1200</b>	4FT/48"x2.6"x3.5"	2*10W	Down	1900LM
<b>BX-802M1-1800</b>	6FT/72"x2.6"x3.5"	3*10W	Down	2850LM
<b>BX-802M1-2400</b>	8FT/95.5"x2.6"x3.5"	6*10W	Down	5700LM

## Light Distribution Curve

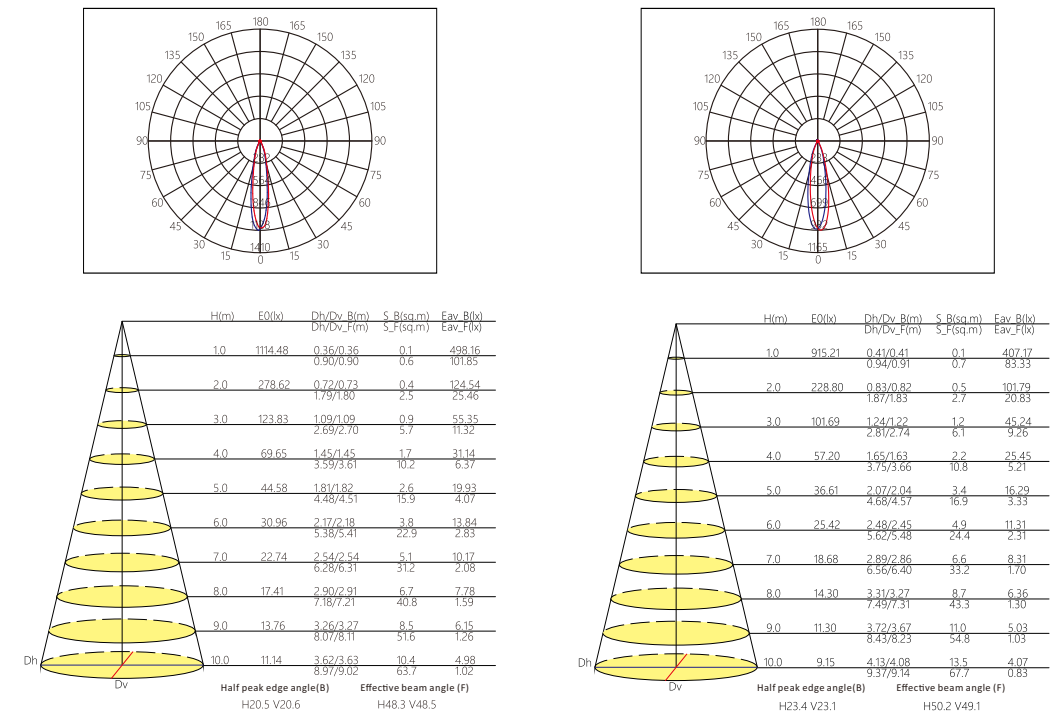

## Length

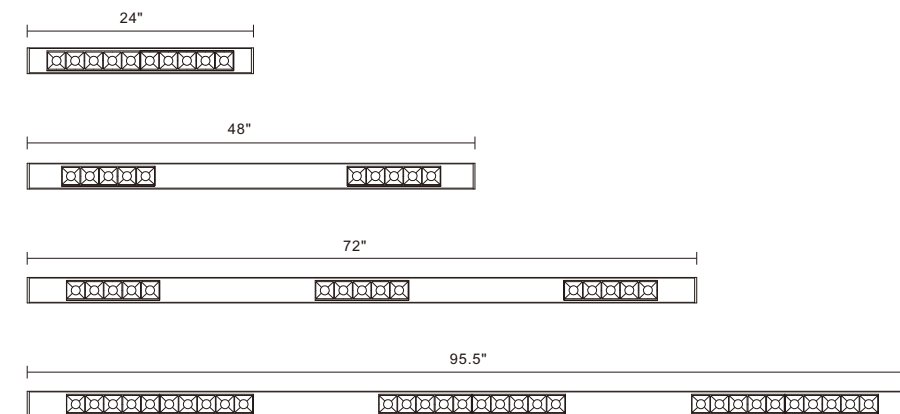

## Mounting



## Combination

<b>LENS</b>	
<b>Size</b>	9"x2"
<b>LED</b>	XPE/XPD/3030/3535
<b>Power</b>	5*(1-5)W
<b>Angle</b>	15° 30° 45°

# BX-802M2

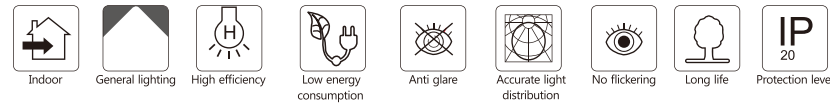

## Product Features 产品特点

- Equipped with non-flicking driver and high lumen SMD led chip.
- Options for 1-10V dimming, dali dimming and color changing driver.
- Long lifespan up to 50000hours, low decay and low maintenance cost.
- Die-casting end-caps, No screw to be appeared, No light leak.
- High grade aluminum, high quality surface painting.
- Fast and easy connection with no shadow.
- High efficiency lens and even light distribution, no shadow, anti-glare feature, easy installation to any shape.
- Application: Office, School, Hospital, Supermarket, Shopping Mall, Hotel, Public Area

- 灯具电器选用无频闪、质保5年品牌驱动电源，配进口高亮度SMD光源，另可选配调光1-10V、DALI调光、调色温驱动电源。
- 寿命长达5万小时，光衰小、减少后期维护费用。
- 无螺丝压铸铝端盖，灯具线条硬朗美观、外观尺寸比例科学合理，安装方式灵活。
- 灯体材料采用优质铝合金，表面静电喷涂处理，坚固耐用不易变色和刮花。
- 高透光透镜，出光均匀，防眩光效果好；灯带系统模组可任意组合，实现不间断无影光的连续光带。
- 应用场所：写字楼、学校、医院、高档超市、商场、酒店、公共场所等。

## Product Size

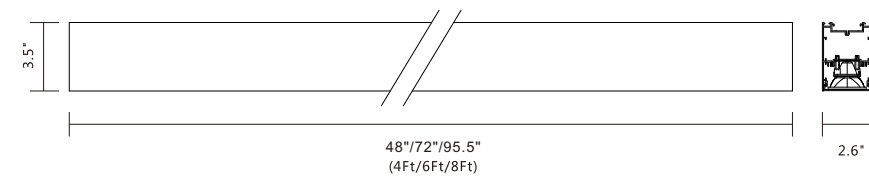

Item No.	Dimension	Power	Distribution	Flux(Lumen)
BX-802M2-1200	4FT/48"x2.6"x3.5"	10W+15W	Down	2400LM
BX-802M2-1800	6FT/72"x2.6"x3.5"	2*10W+20W	Down	3600LM
BX-802M2-2400	8FT/95.5"x2.6"x3.5"	4*10W+20W	Down	5700LM

## Light Distribution Curve

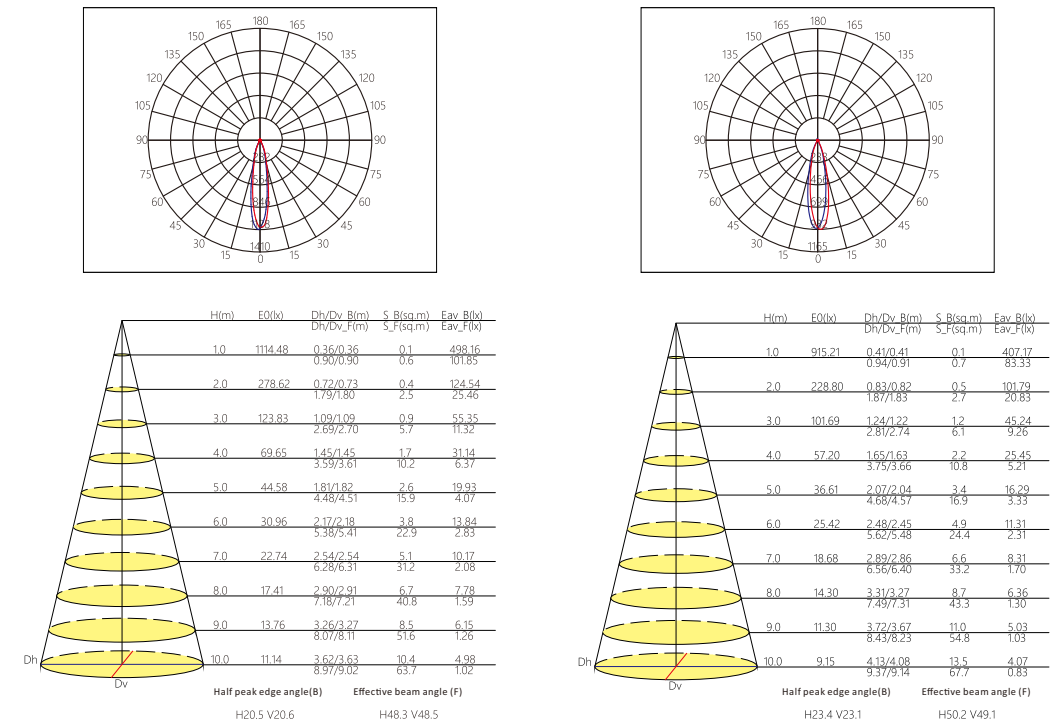

## Length

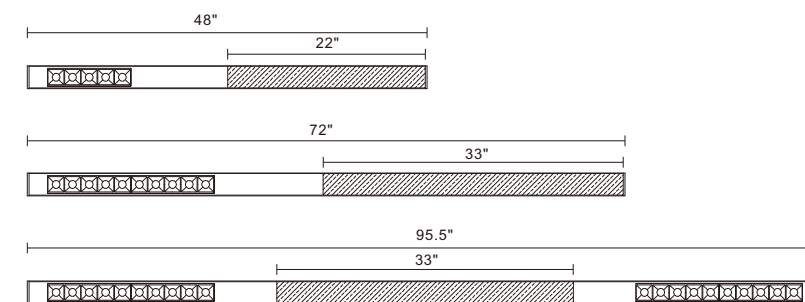

## Combination

LENS	
Size	9"x2"
LED	XPE/XPD/3030/3535
Power	5*(1-5)W
Angle	15° 30° 45°

PMMA	
LED	2835
Power	30W/M
Efficacy	100Lm/W

## Mounting



## Dimming



# BX-802M3



## Product Features

- Equipped with non-flicking driver and high lumen SMD led chip,
- Options for 1-10V dimming,dali dimming and color changing driver.
- Long lifespan up to 50000hours,low decay and low maintenance cost.
- Die-casting end-caps,No screw to be appeared,No light leak.
- High grade aluminum,high quality surface painting.
- Fast and easy connection with no shadow.
- High efficiency lens and even light .distributon,anti-glare feature,
- easy installation to any shape.
- Application:Office,School,Hospital,Supermarket,Shopping Mall,Hotel,Public Area

## Product Size

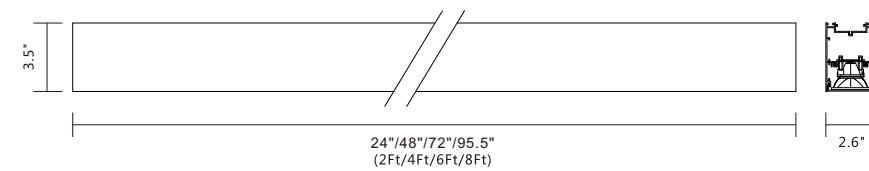

Item No.	Dimension	Power	Distribution	Flux(Lumen)
<b>BX-802M3-600</b>	2FT/24"x2.6"x3.5"	5*3W	Down	1425LM
<b>BX-802M3-1200</b>	4FT/48"x2.6"x3.5"	6*3W	Down	1710LM
<b>BX-802M3-1800</b>	6FT/72"x2.6"x3.5"	8*3W	Down	2280LM
<b>BX-802M3-2400</b>	8FT/95.5"x2.6"x3.5"	10*3W	Down	2850LM

## Light Distribution Curve

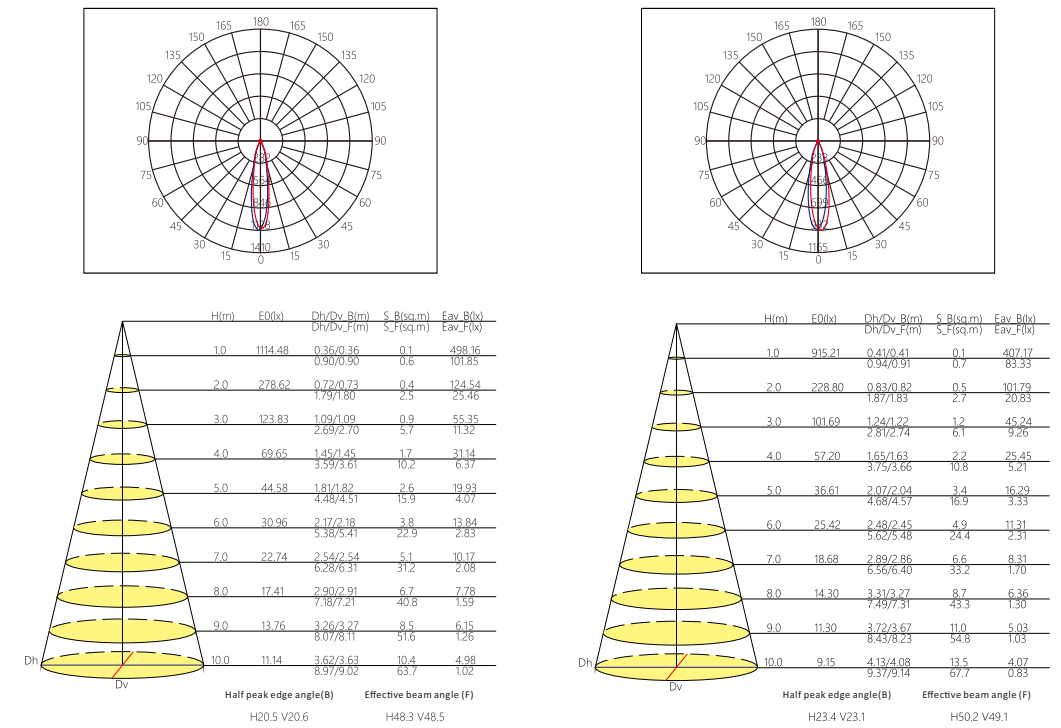

## Length

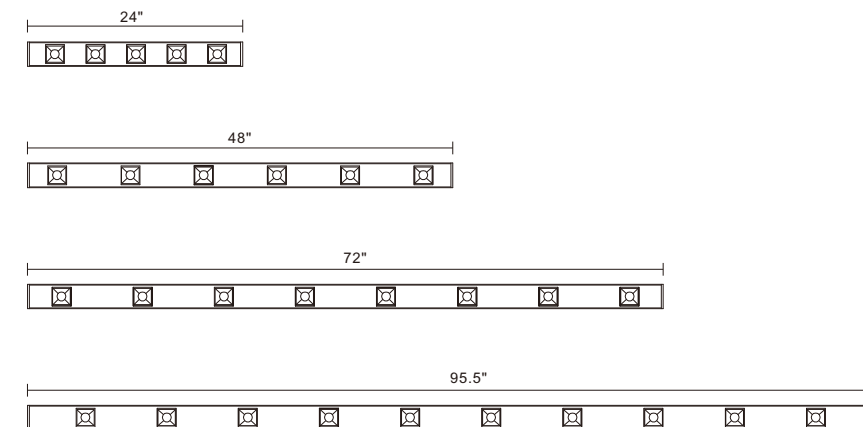

## Mounting



## Combination

<b>LENS</b>	
<b>Size</b>	1.96"x1.96"
<b>LED</b>	XPE/XPD/3030/3535
<b>Power</b>	1-5W
<b>Angle</b>	15° 30° 45°

# BX-802M4

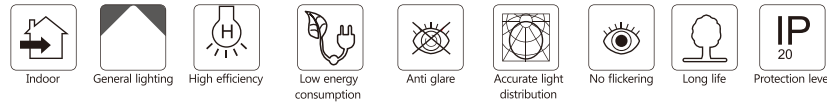

## Product Features

- Equipped with non-flicking driver and high lumen SMD led chip,
- Options for 1-10V dimming,dali dimming and color changing driver.
- Long lifespan up to 50000hours,low decay and low maintenance cost.
- Die-casting end-caps,No screw to be appeared,No light leak.
- High grade aluminum,high quality surface painting.
- Fast and easy connection with no shadow.
- High efficiency lens and even light .distribution,no shawdon,anti-glare feature,
- easy installation to any shape.
- Application:Office,School,Hospital,Supermarket,Shopping Mall,Hotel,Public Area

## Product Size

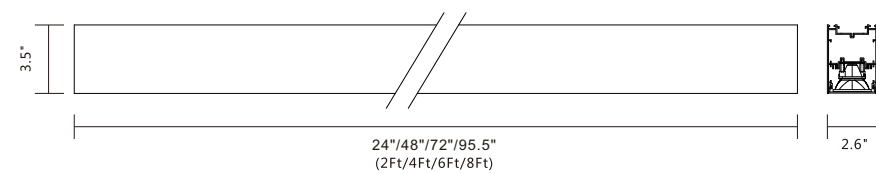

Item No.	Dimension	Power	Distribution	Flux(Lumen)
<b>BX-802M4-600</b>	2FT/24"x2.6"x3.5"	5*3W	Down	1425LM
<b>BX-802M4-1200</b>	4FT/48"x2.6"x3.5"	6*3W	Down	1710LM
<b>BX-802M4-1800</b>	6FT/72"x2.6"x3.5"	8*3W	Down	2280LM
<b>BX-802M4-2400</b>	8FT/95.5"x2.6"x3.5"	10*3W	Down	2850LM

## Light Distribution Curve

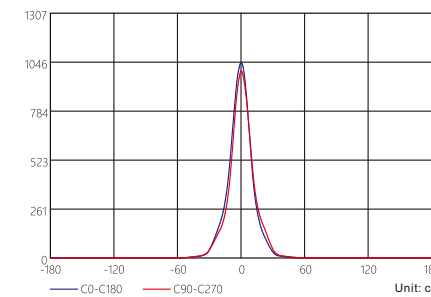
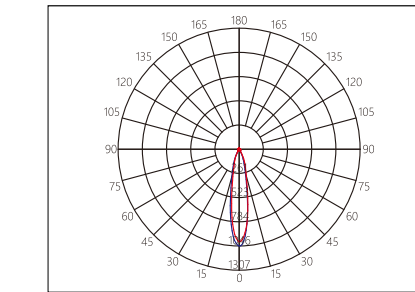

H(m)	E0(lx)	Dh/Dv R(m)	S R(sq.m)	Sv F(sq.m)	Eav R(lx)	Eav F(lx)
1.0	1046.07	0.36/0.35	0.1	0.7	460.20	92.64
2.0	261.52	0.71/0.70	0.4	2.7	115.05	23.16
3.0	116.23	1.07/1.05	0.9	6.0	51.13	10.29
4.0	65.38	1.42/1.41	1.6	10.7	28.76	5.79
5.0	41.84	1.78/1.76	2.5	16.7	18.41	3.71
6.0	29.06	2.14/2.11	3.5	24.0	12.78	2.57
7.0	21.35	2.49/2.46	4.8	32.7	9.39	1.89
8.0	16.34	2.85/2.81	6.3	42.7	7.19	1.45
9.0	12.91	3.20/3.16	8.0	54.1	5.68	1.14
10.0	10.46	3.56/3.52	9.8	66.8	4.60	0.93

Half peak edge angle(B) H20.2 V19.9  
 Effective beam angle (F) H48.3 V50.6

## Length

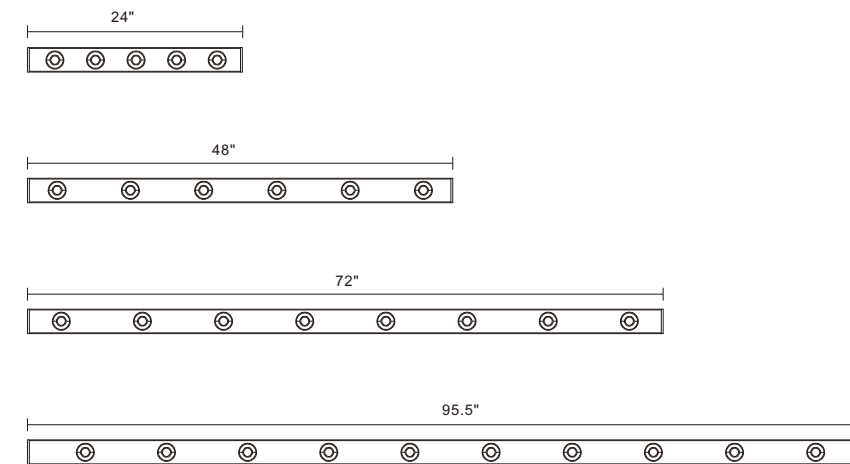

## Mounting



## Combination

<b>LENS</b>	
<b>Size</b>	D1.96"
<b>LED</b>	XPE/XPD/3030/3535
<b>Power</b>	1-5W

# BX-802M5



## Product Features

- Equipped with non-flicking driver and high lumen SMD led chip,
- Options for 1-10V dimming,dali dimming and color changing driver.
- Long lifespan up to 50000hours,low decay and low maintenance cost.
- Die-casting end-caps,No screw to be appeared,No light leak.
- High grade aluminum,high quality surface painting.
- Fast and easy connection with no shadow.
- High efficiency lens and even light .distribrion,no shawdon,anti-glare feature, easy installation to any shape.
- Application:Office,School,Hospital,Supermarket,Shopping Mall,Hotel,Public Area

## Product Size

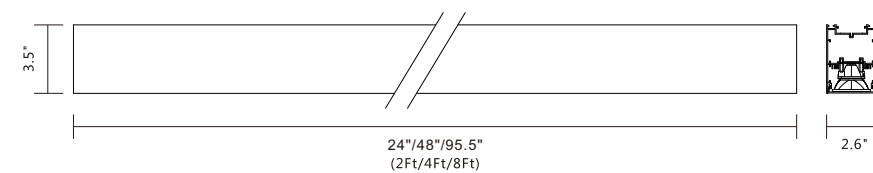

Item No.	Dimension	Power	Distribution	Flux(Lumen)
BX-802M5-1200	2FT/24"x2.6"x3.5"	5*3W+2*2Spot light	Down	1710LM
BX-802M5-1800	6FT/48"x2.6"x3.5"	10*3W+4Spot light	Down	2280LM
BX-802M5-2400	8FT/95.5"x2.6"x3.5"	10*3W+6Spot light	Down	2850LM

## Light Distribution Curve

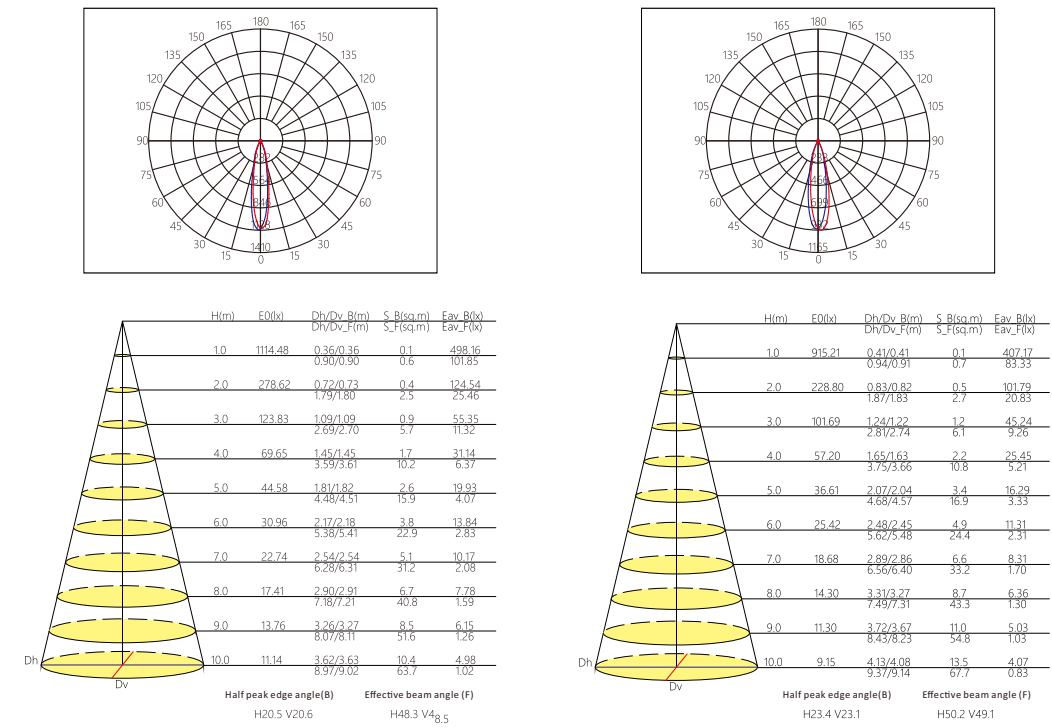

## Length

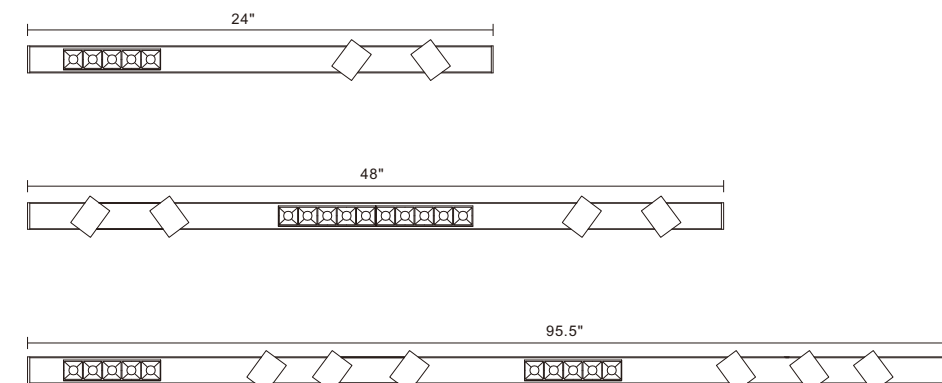

## Mounting



## Combination

LENS	
Size	9.3"x1.96"
LED	XPE/XPD/3030/3535
Power	5*(1-5)W
Angle	15° 30° 45°

# BX-802M6

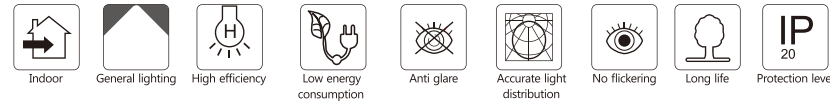

## Product Features

- Equipped with non-flicking driver and high lumen SMD led chip.
- Options for 1-10V dimming,dali dimming and color changing driver.
- Long lifespan up to 50000hours,low decay and low maintenance cost.
- Die-casting end-caps,No screw to be appeared,No light leak.
- High grade aluminum,high quality surface painting.
- Fast and easy connection with no shadow.
- High efficiency lens and even light .distribution,no shadow,anti-glare feature, easy installation to any shape.
- Application:Office,School,Hospital,Supermarket,Shopping Mall,Hotel,Public Area

## Product Size

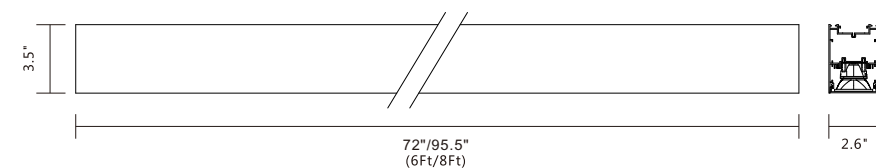

Item No.	Dimension	Power	Distribution	Flux(Lumen)
BX-802M6-1800	6FT/72"x2.6"x3.5"	1*10W+10W+2*Spot light	Down	1900LM
BX-802M6-2400	8FT/95.5"x2.6"x3.5"	2*10W+20W+2*Spot light	Down	3800LM

## Light Distribution Curve

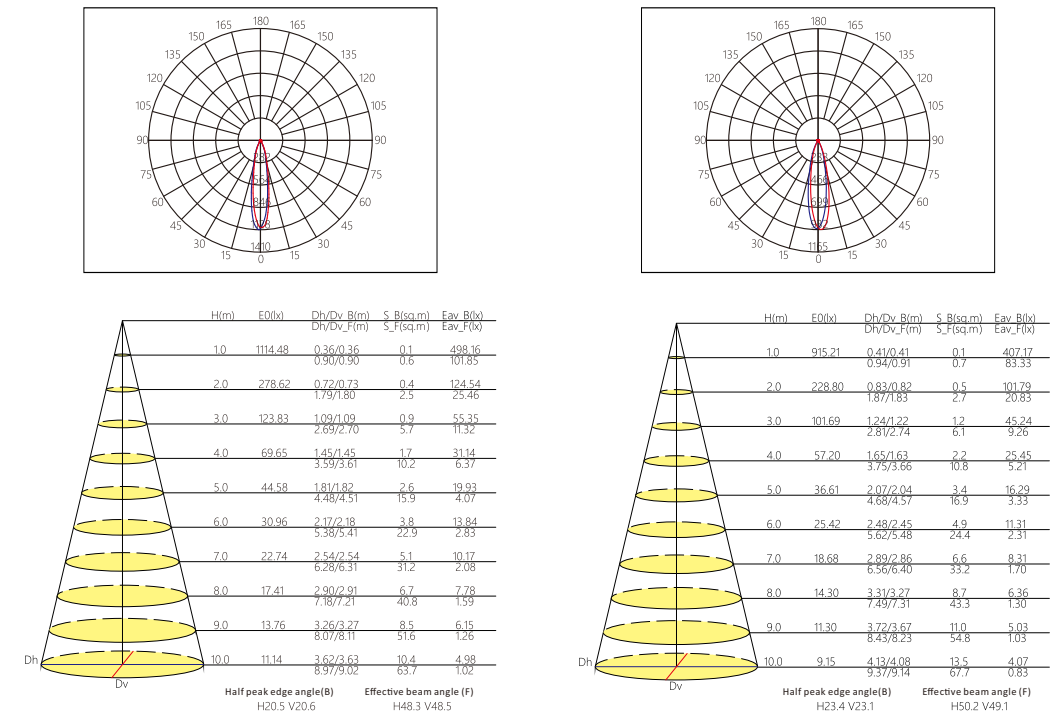

## Length

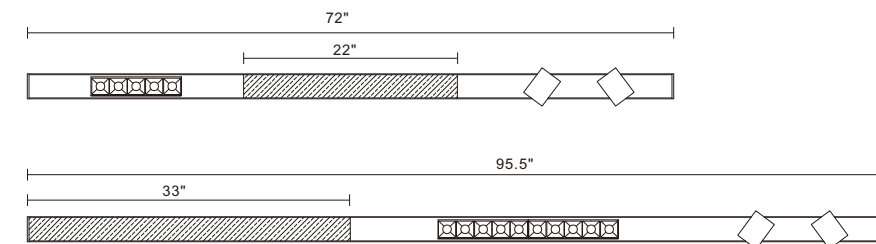

## Combination

LENS	
Size	9.3"x1.96"
LED	XPE/XPD/3030/3535
Power	5*(1-5)W
Angle	15° 30° 45°

PMMA	
LED	2835
Power	30W/M
Efficacy	100Lm/W

## Mounting





# BX-804M1



## Product Features

- Equipped with non-flicking driver and high lumen SMD led chip,
- Options for 1-10V dimming,dali dimming and color changing driver.
- Long lifespan up to 50000hours,low decay and low maintenance cost.
- Die-casting end-caps,No screw to be appeared,No light leak.
- High grade aluminum,high quality surface painting.
- Fast and easy connection with no shadow.
- High efficiency lens and even light .distribution,no shadow,anti-glare feature, easy installation to any shape.
- Application:Office,School,Hospital,Supermarket,Shopping Mall,Hotel,Public Area

## Product Size

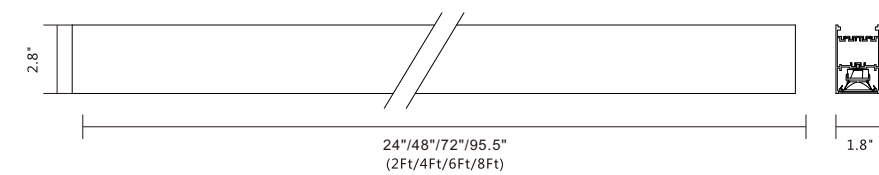

Item No.	Dimension	Power	Distribution	Flux(Lumen)
BX-804M1-600	2FT/24"x1.8"x2.8"	2*5W	Down	950LM
BX-804M1-1200	4FT/48"x1.8"x2.8"	4*5W	Down	1900LM
BX-804M1-1800	6FT/72"x1.8"x2.8"	6*5W	Down	2850LM
BX-804M1-2400	8FT/95.5"x1.8"x2.8"	8*5W	Down	3800LM

## Light Distribution Curve

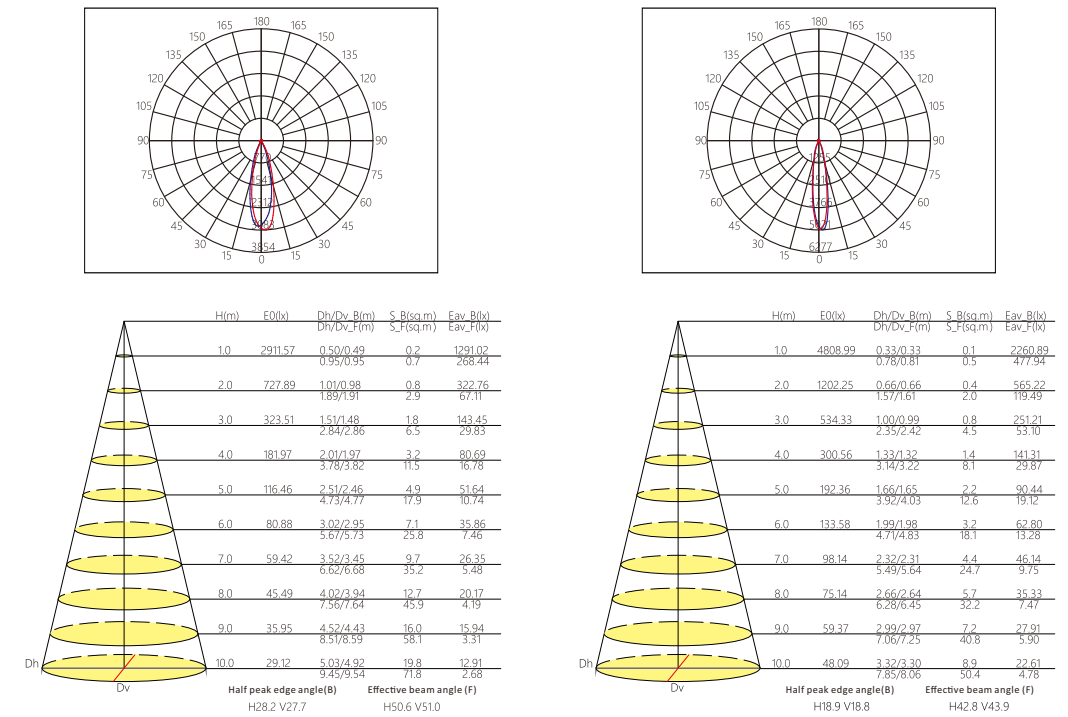

## Length

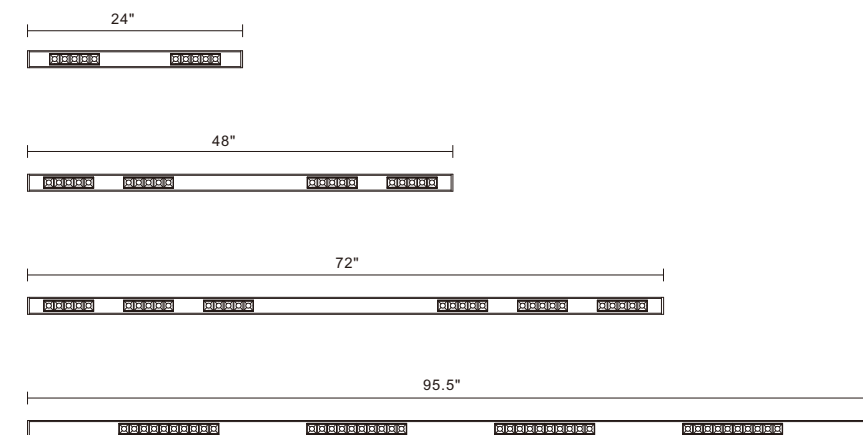

## Mounting



## Combination

LENS	
Size	5.2"x1.2"
LED	XPE/XPD/3030/3535
Power	5*(1-3)W
Angle	15° 30° 45°



# BX-804M2



## Product Features

- Equipped with non-flicking driver and high lumen SMD led chip,
- Options for 1-10V dimming,dali dimming and color changing driver.
- Long lifespan up to 50000hours,low decay and low maintenance cost.
- Die-casting end-caps,No screw to be appeared,No light leak.
- High grade aluminum,high quality surface painting.
- Fast and easy connection with no shadow.
- High efficiency lens and even light .distribution,no shadow,anti-glare feature, easy installation to any shape.
- Application:Office,School,Hospital,Supermarket,Shopping Mall,Hotel,Public Area

## Product Size

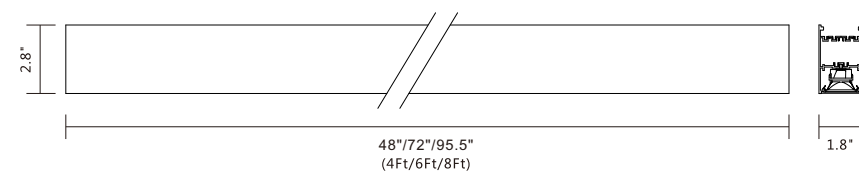

Item No.	Dimension	Power	Distribution	Flux(Lumen)
BX-804M2-1200	4FT/48"x1.8"x2.8"	2*5W+10W	Down	1900LM
BX-804M2-1800	6FT/72"x1.8"x2.8"	2*5W+20W	Down	2850LM
BX-804M2-2400	8FT/95.5"x1.8"x2.8"	4.5W+36W	Down	3800LM

## Light Distribution Curve

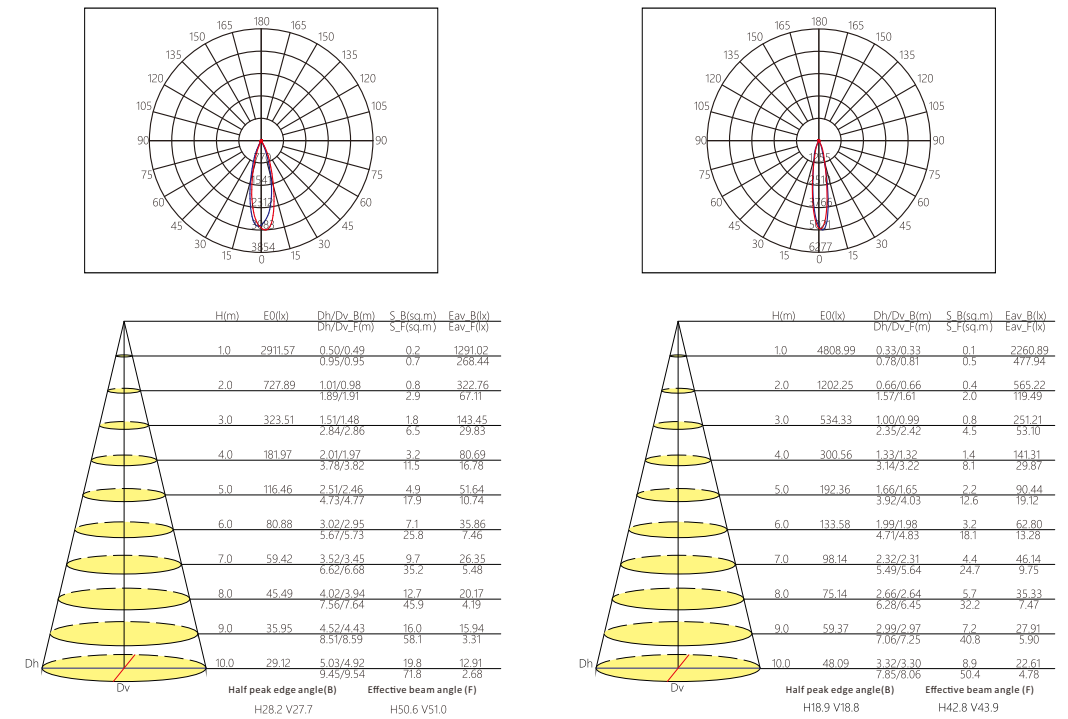

## Length

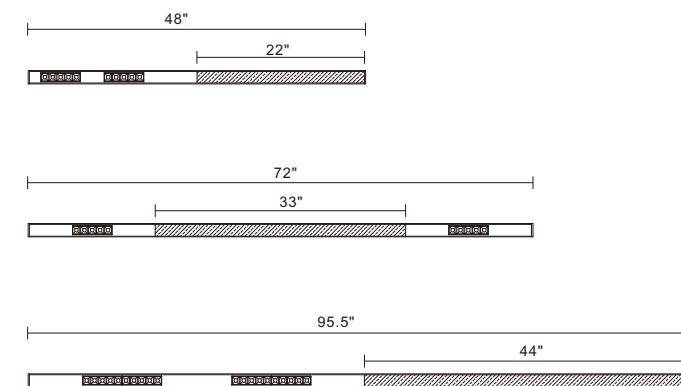

## Mounting



## Combination

LENS	
Size	5.2"x1.2"
LED	XPE/XPD/3030/3535
Power	5*(1-3)W
Angle	15° 30° 45°



**BeatiLux<sup>®</sup>**



# BX-810M1



## Product Features

- Equipped with non-flicking driver and high lumen SMD led chip.
- Options for 1-10V dimming,dali dimming and color changing driver.
- Long lifespan up to 50000hours,low decay and low maintenance cost.
- Die-casting end-caps,No screw to be appeared,No light leak.
- High grade aluminum,high quality surface painting.
- Fast and easy connection with no shadow.
- High efficiency lens and even light .distribution,no shadow,anti-glare feature, easy installation to any shape.
- Application:Office,School,Hospital,Supermarket,Shopping Mall,Hotel,Public Area

## Product Size

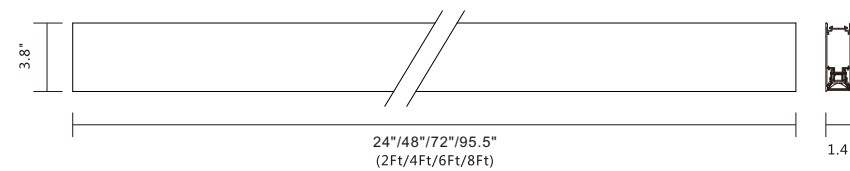

Item No.	Dimension	Power	Distribution	Flux(Lumen)
<b>BX-810M1-600</b>	2FT/24"x1.4"x3.8"	2*5W	Down	950LM
<b>BX-810M1-1200</b>	4FT/48"x1.4"x3.8"	4*5W	Down	1900LM
<b>BX-810M1-1800</b>	6FT/72"x1.4"x3.8"	6*5W	Down	2850LM
<b>BX-810M1-2400</b>	8FT/95.5"x1.4"x3.8"	8*5W	Down	3800LM

## Light Distribution Curve

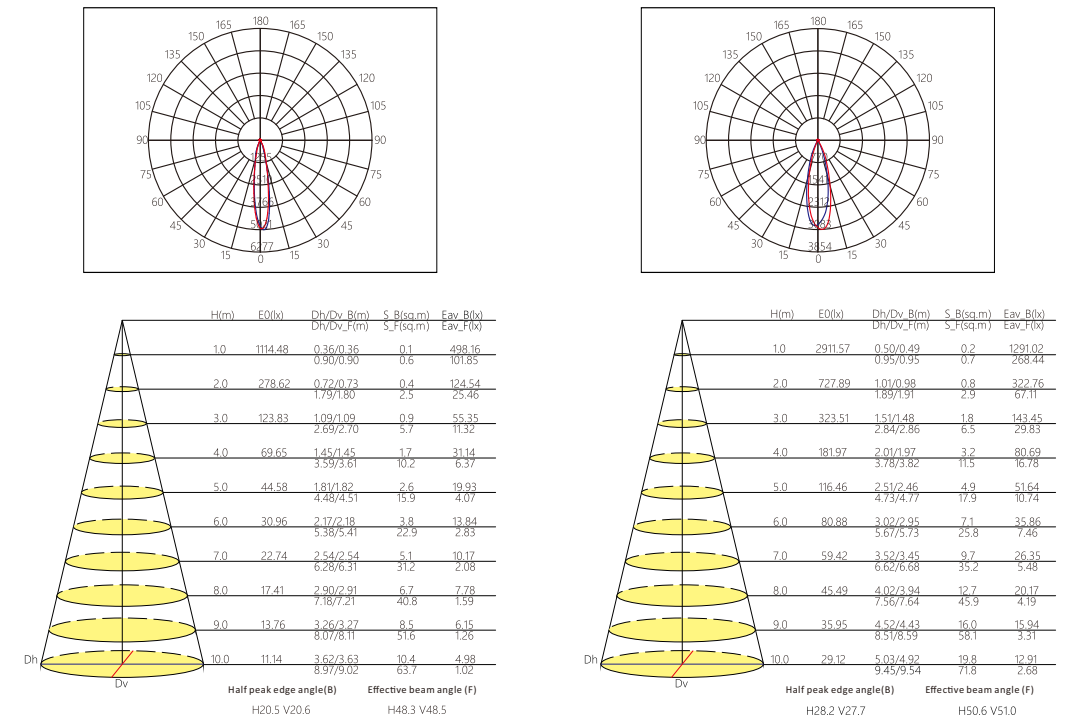

## Length

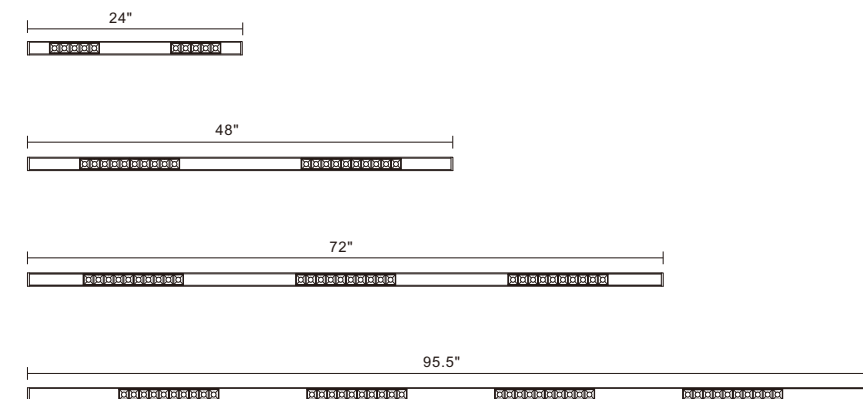

## Mounting



## Combination

LENS	
<b>Size</b>	5.2"x1.2"
<b>LED</b>	XPE/XPD/3030/3535
<b>Power</b>	5*(1-3)W
<b>Angle</b>	15° 30° 45°

# BX-810M7



## Product Features

- Equipped with non-flicking driver and high lumen SMD led chip,
- Options for 1-10V dimming,dali dimming and color changing driver.
- Long lifespan up to 50000hours,low decay and low maintenance cost.
- Die-casting end-caps,No screw to be appeared,No light leak.
- High grade aluminum,high quality surface painting.
- Fast and easy connection with no shadow.
- High efficiency lens and even light .distribution,no shadow,anti-glare feature, easy installation to any shape.
- Application:Office,School,Hospital,Supermarket,Shopping Mall,Hotel,Public Area

## Product Size

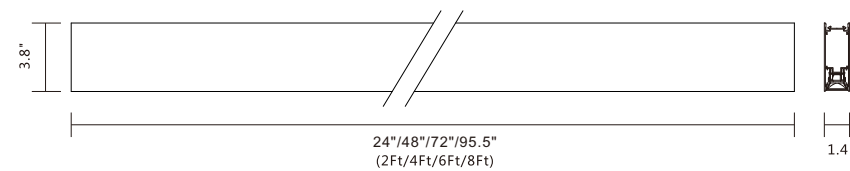

Item No.	Dimension	Power	Distribution	Flux(Lumen)
<b>BX-810M7-500</b>	2FT/24"x1.4"x3.8"	4*5W	Down	1900LM
<b>BX-810M7-800</b>	4FT/48"x1.4"x3.8"	6*5W	Down	2850LM
<b>BX-810M7-1000</b>	6FT/72"x1.4"x3.8"	8*5W	Down	3800LM
<b>BX-810M7-1200</b>	8FT/95.5"x1.4"x3.8"	9*5W	Down	4275LM

## Light Distribution Curve

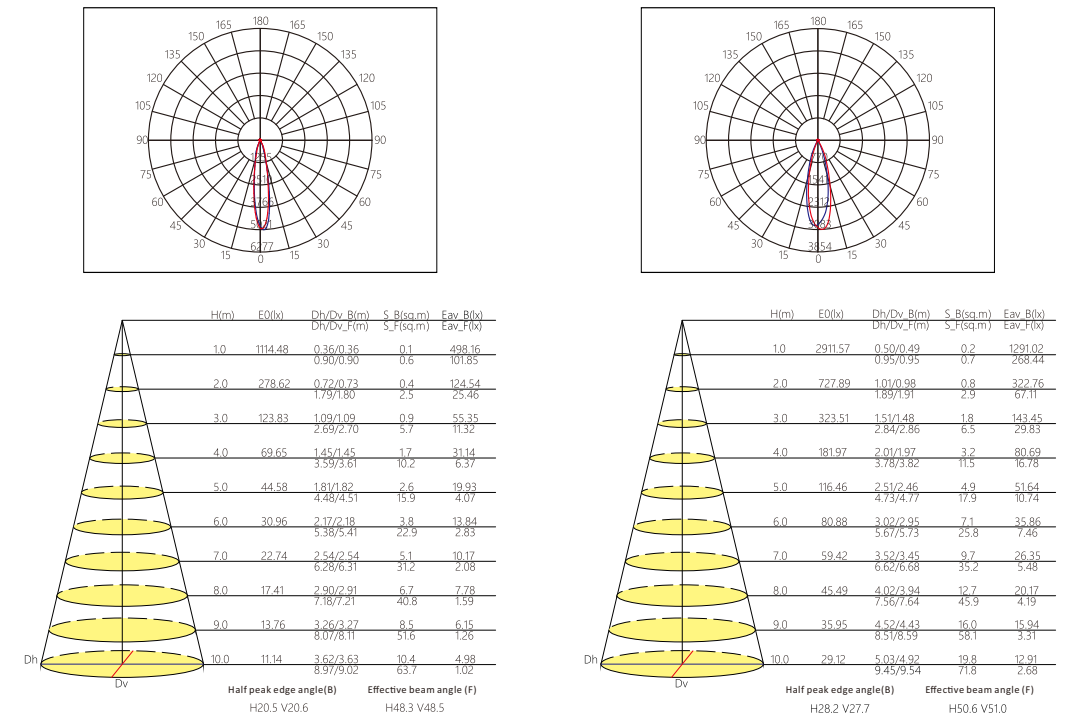

## Length

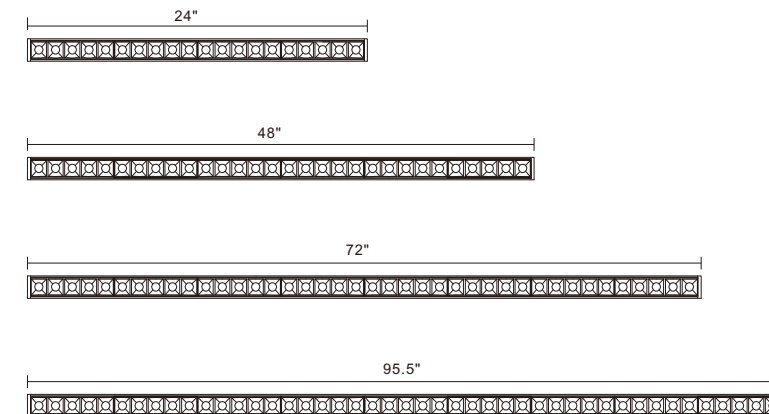

## Mounting



## Combination

<b>LENS</b>	
<b>Size</b>	5.2"x1.2"
<b>LED</b>	XPE/XPD/3030/3535
<b>Power</b>	5*(1-3)W
<b>Angle</b>	15° 30° 45°

# BX-905A

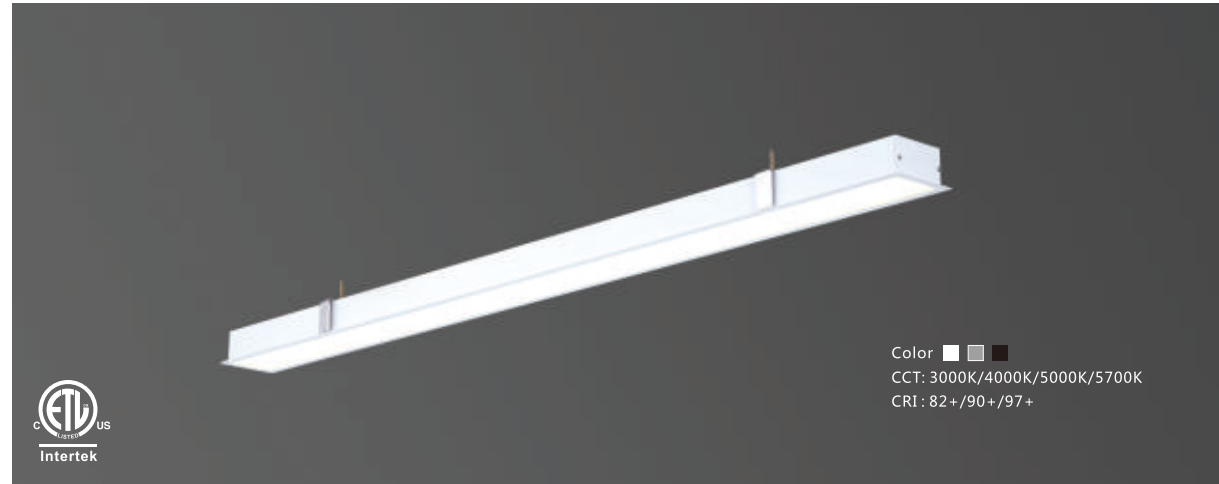

## Product Features

- Equipped with non-flicking driver and high lumen SMD led chip,
- Options for 1-10V dimming,dali dimming and color changing driver.
- Long lifespan up to 50000hours,low decay and low maintenance cost.
- Die-casting end-caps,No screw to be appeared,No light leak.
- High grade aluminum,high quality surface painting.
- Fast and easy connection with no shadow.
- High efficiency PMMA and even light .distribution,no shadow,anti-glare feature, easy installation to any shape.
- Application:Office,School,Hospital,Supermarket,Shopping Mall,Hotel,Public Area

## Product Size

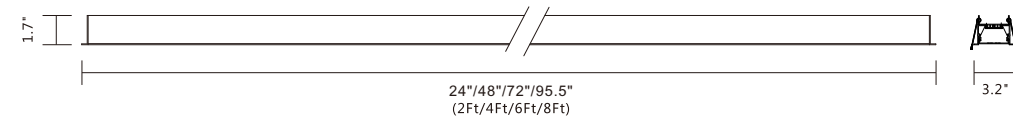

Item No.	Dimension	Power	Distribution	Flux(Lumen)
<b>BX-905A-600-18W</b>	2FT/24"x3.2"x1.7"	18W	Down	1800LM
<b>BX-905A-1200-36W</b>	4FT/48"x3.2"x1.7"	36W	Down	3600LM
<b>BX-905A-1800-54W</b>	6FT/72"x3.2"x1.7"	54W	Down	5400LM
<b>BX-905A-2400-72W</b>	8FT/95.5"x3.2"x1.7"	72W	Down	7200LM

## Light Distribution Curve

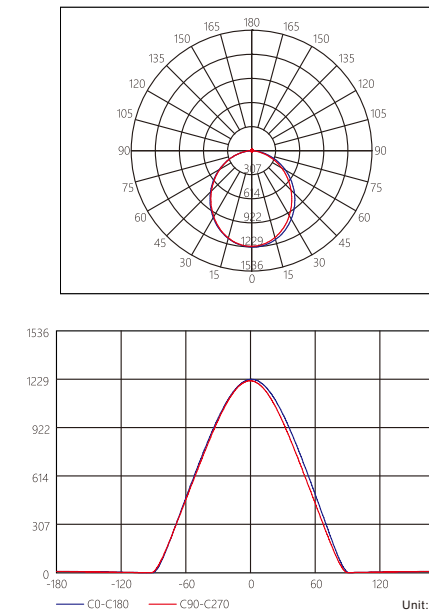

H(m)	E0(ft)	Dh/Dv (ft)	S. B(ft²)	Eav. B(ft)
1.0	1229.39	2.66/2.49	5.2	241.54
2.0	307.35	5.33/4.97	20.9	60.39
3.0	136.60	7.99/7.46	47.0	26.84
4.0	76.84	10.66/9.95	83.6	15.10
5.0	49.18	13.32/12.43	130.6	9.66
6.0	34.15	15.99/14.92	188.1	6.71
7.0	25.09	18.65/17.41	256.0	4.93
8.0	19.21	21.32/19.89	334.4	3.77
10.0	12.29	26.65/24.87	522.5	2.42
12.0	8.54	31.97/29.84	752.4	1.68

Half peak angle(B) H106.2 V102.4  
 Effective beam angle (F) H159.7 V158.4

## Connector

	180° extender	3.1"x0.8"x0.05"		L-shape Connector	12.9"x12"x3"x1.7"
	T-shape Connector	11"x13.5"x3"x1.7"		X-shape Connector	24.4"x11"x3"x1.7"

## Mounting

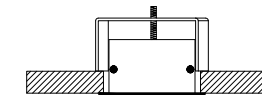

## Dimming



## Linear Continuous

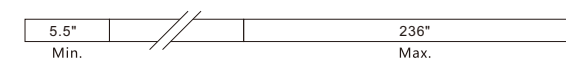

# BX-908A



## Product Features

- Equipped with non-flicking driver and high lumen SMD led chip,
- Options for 1-10V dimming,dali dimming and color changing driver.
- Long lifespan up to 50000hours,low decay and low maintenance cost.
- Die-casting end-caps,No screw to be appeared,No light leak.
- High grade aluminum,high quality surface painting.
- Fast and easy connection with no shadow.
- High efficiency PMMA and even light .distribution,no shawdon,anti-glare feature, easy installation to any shape.
- Application:Office,School,Hospital,Supermarket,Shopping Mall,Hotel,Public Area

## Product Size

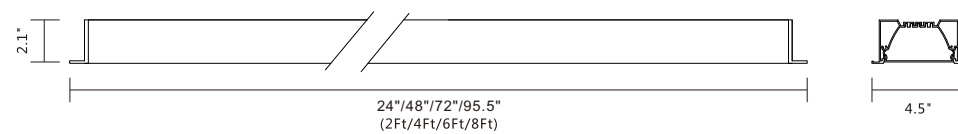

Item No.	Dimension	Power	Distribution	Flux(Lumen)
<b>BX-908A-600-18W</b>	2FT/24"x4.5"x2.1"	18W	Down	1800LM
<b>BX-908A-1200-36W</b>	4FT/48"x4.5"x2.1"	36W	Down	3600LM
<b>BX-908A-1800-54W</b>	6FT/72"x4.5"x2.1"	54W	Down	5400LM
<b>BX-908A-2400-72W</b>	8FT/95.5"x4.5"x2.1"	72W	Down	7200LM

## Light Distribution Curve

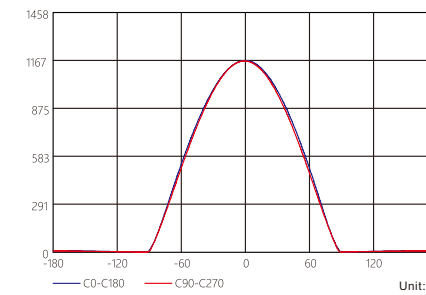
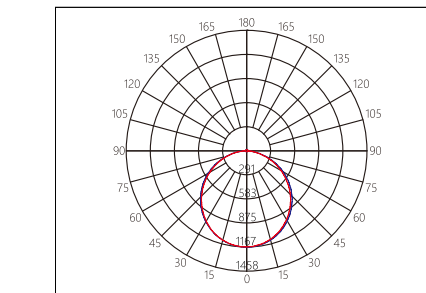

H(m)	E0(lx)	Dh/Dv_B(m)	S_B(sq.m)	Env_B(lx)
1.0	1167.00	3.06/2.90	7.0	195.69
2.0	291.75	6.13/5.81	27.9	48.92
3.0	129.67	9.19/8.71	62.7	21.74
4.0	72.94	12.25/11.61	111.5	12.23
5.0	46.68	15.32/14.52	174.2	7.83
6.0	32.42	18.38/17.42	250.8	5.44
7.0	23.82	21.44/20.33	341.4	3.99
8.0	18.23	24.51/23.23	445.9	3.06
10.0	11.67	30.63/29.04	696.8	1.96
12.0	8.10	36.76/34.84	1003.3	1.36

Half peak angle(B) H113.7 V110.9 Effective beam angle (F) H162.3 V162.0

## Connector

	180° extender	3"x1.5"x0.9"		L-shape Connector	8.8"x7"x4.5"x2"
	T-shape Connector	11"x8.8"x4.5"x2"		X-shape Connector	13"x11"x4.5"x2"

## Mounting

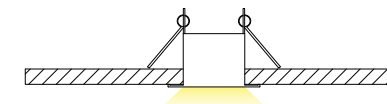

## Dimming



## Linear Continuous

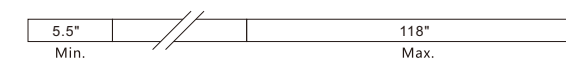



**BeatiLux®**  
**FREE SPLICING**  
**variable shape**

# BX-817A



## Product Features

- Equipped with non-flicking driver and high lumen SMD led chip,
- Options for 1-10V dimming,dali dimming and color changing driver.
- Long lifespan up to 50000hours,low decay and low maintenance cost.
- Die-casting end-caps,No screw to be appeared,No light leak.
- High grade aluminum,high quality surface painting.
- Fast and easy connection with no shadow.
- High efficiency PC and even light .distribution,no shadow,anti-glare feature,
- easy installation to any shape.
- Application:Office,School,Hospital,Supermarket,Shopping Mall,Hotel,Public Area

## Product Size

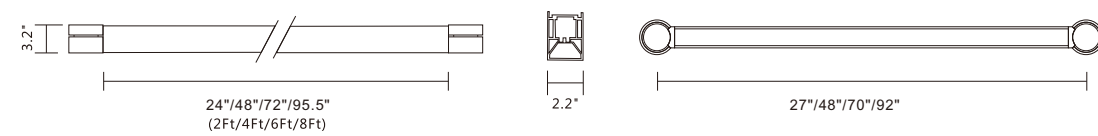

Item No.	Dimension	Power	Distribution	Flux(Lumen)
<b>BX-817A-600-18W</b>	2FT/24.2"x2.2"x3.2"	18W	Down	2160LM
<b>BX-817A-1200-36W</b>	4FT/48"x2.2"x3.2"	36W	Down	4320LM
<b>BX-817A-1800-54W</b>	6FT/72"x2.2"x3.2"	54W	Down	6480LM
<b>BX-817A-2400-72W</b>	8FT/95.5"x2.2"x3.2"	72W	Down	8640LM



## Regular shapes

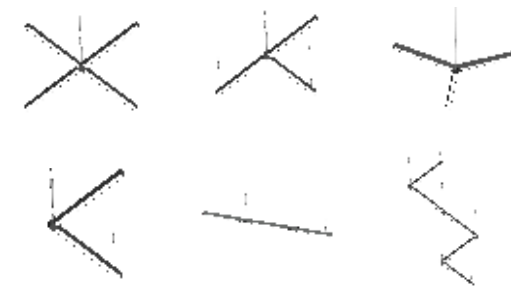

## More shapes

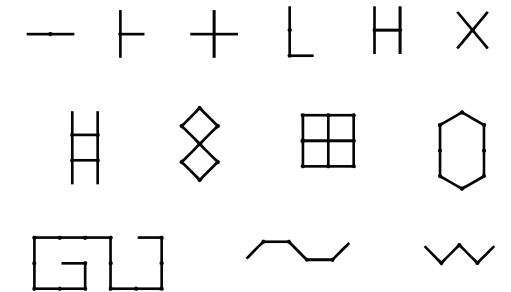

## Dimming



## Accessories

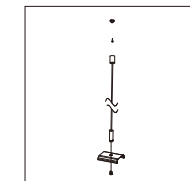

## Mounting





Special designed non-illuminated lighting segment connector.

- Can realize both electronic and structural connection.
- One connector with max 4 branches outputs.
- With fast connectors to the lamp, installation in seconds without any tools.
- Both dimmable and no-dimmable version available, per-wired 5 cables at maximum



AFTER CONNECTING THE LAMP TO THE CONNECTOR, THE LAMP CAN ROTATE 30° AT TWO DIFFERENT DIRECTIONS



Connector

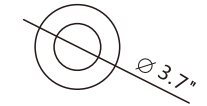
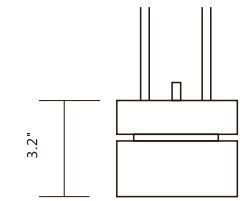

Angle Rotation Introduction

